

1858878COM TV Stand 1866878COM TV Stand With Fireplace

Ameriwood HOME

Date of Purchase ___ / ___ / ___
Lot Number:

B341858878COM00

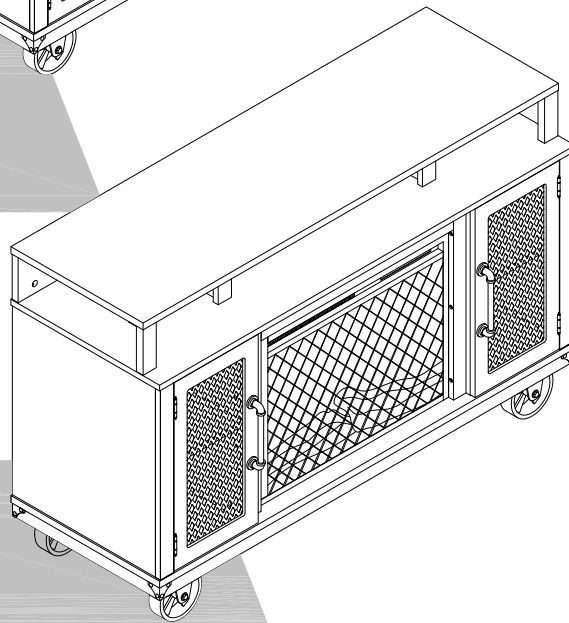
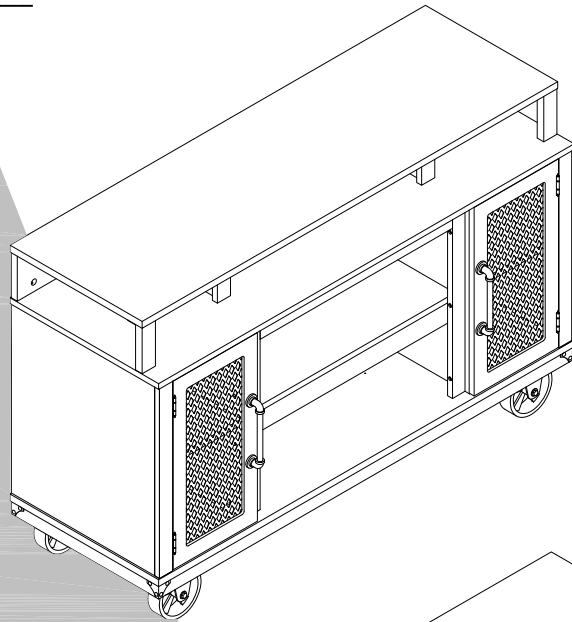

THIS INSTRUCTION BOOKLET CONTAINS **IMPORTANT** SAFETY INFORMATION. PLEASE READ AND KEEP FOR FUTURE REFERENCE.

Do Not Return This Product!

Contact our customer service team for help first.

Call: 1-800-489-3351 (toll free)

Monday-Friday 9am - 5pm CST

Visit: www.ameriwoodhome.com

WARNING

- Unit can tip over causing severe injury or death.
- Anchor unit to stud in wall (if instructed to).
- Do Not allow children to climb on unit.
- Put heavy items on lower shelves or drawers.

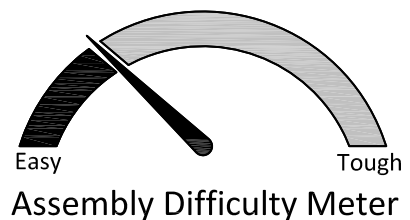

Follow Ameriwood Home



Contact Us!

Do NOT return this product!

Contact our friendly customer service team first for help.

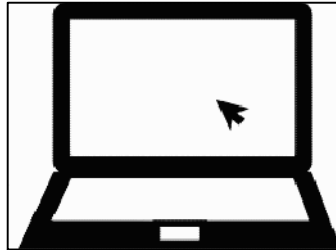
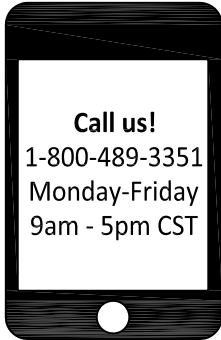

Visit ameriwoodhome.com

Assembly Tips



Helpful Hints

PEOPLE NEEDED FOR ASSEMBLY: **1-2**
ESTIMATED ASSEMBLY TIME: **1 HOUR**

- Open your item in the area you plan to keep it to avoid excessive heavy lifting.
- Identify, sort and count the parts before attempting assembly.
- Compression dowels are lightly tapped in with a hammer.
- Slides are labeled with a **R** (right) and **L** (left) for proper placement.
- Make sure to always face the point on the top of the Cam Lock towards the outer edge.
- Use all the nails provided for the back panel and spread them out equally.
- Back panel must be used to make sure your unit is sturdy.
- Do NOT use harsh chemicals or abrasive cleaners on this item.
- Never push, pull, or drag your furniture.

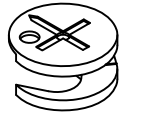

Before You Start

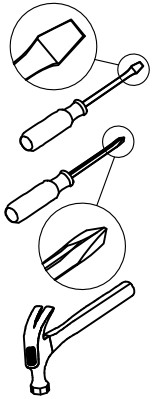
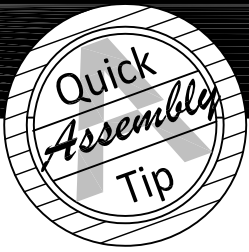

- ✓ Read through each step carefully and follow the proper order
- ✓ Separate and count all your parts and hardware
- ✓ Give yourself enough room for the assembly process
- ✓ Have the following tools: Flat Head Screwdriver, #2 Phillips Head Screwdriver and Hammer
- ✓ Caution: If using a power drill or power screwdriver for screwing, please be aware to slow down and stop when screw is tight. Failure to do so may result in stripping the screw.

Cam Lock Fastening System

This Cam Lock Fastening System will be used throughout the assembly process.

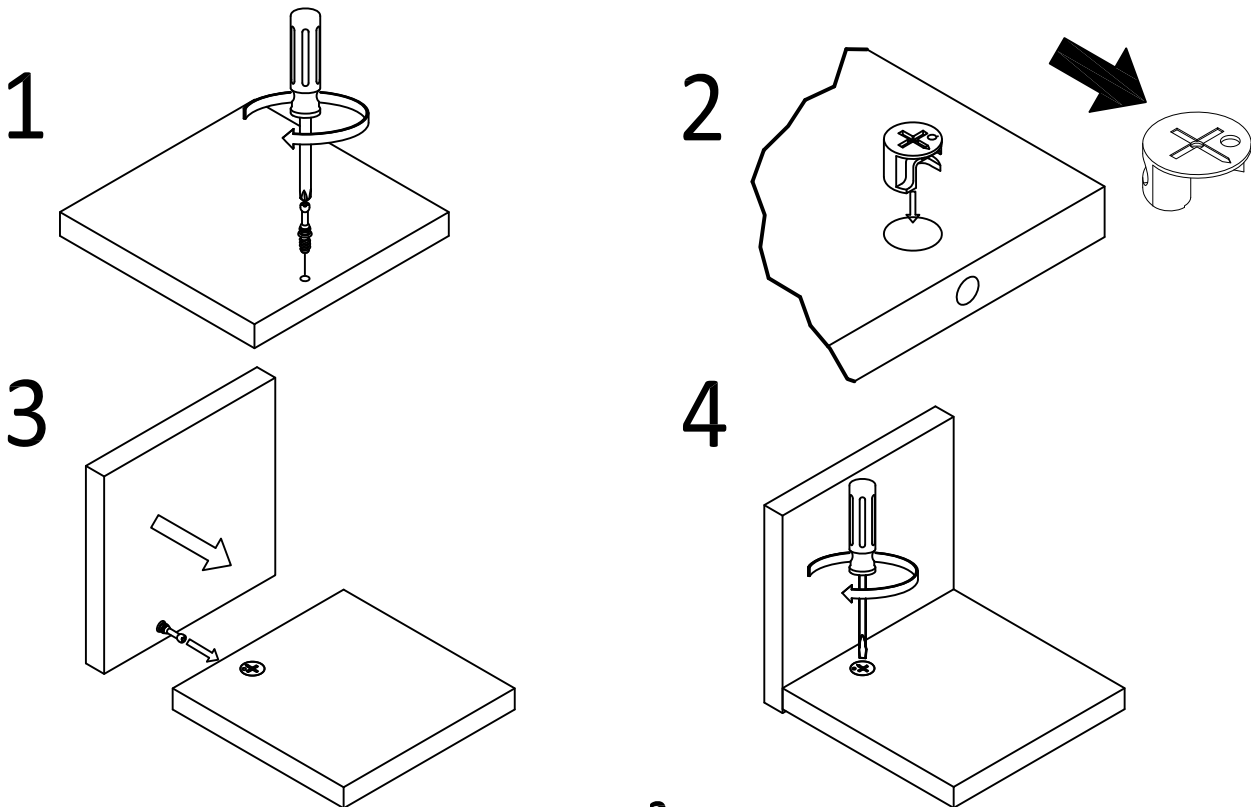

Board Identification

Not actual size

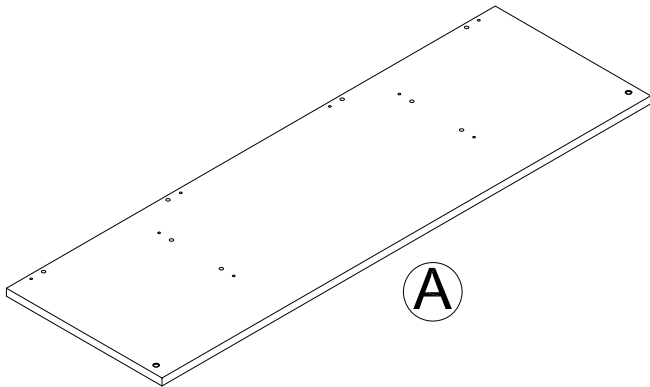

TOP SHELF
T1858878COM010

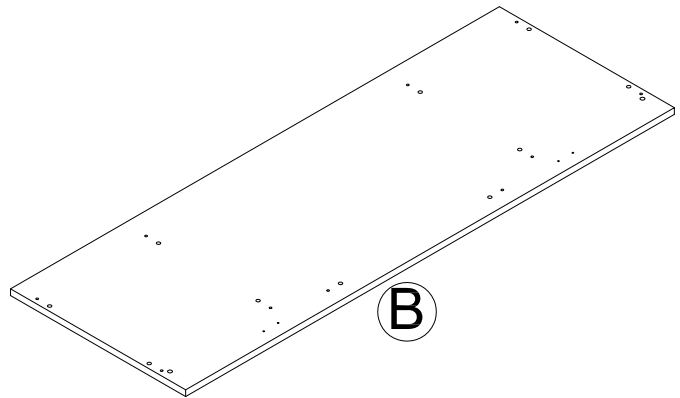

MIDDLE PANEL
T1858878COM020

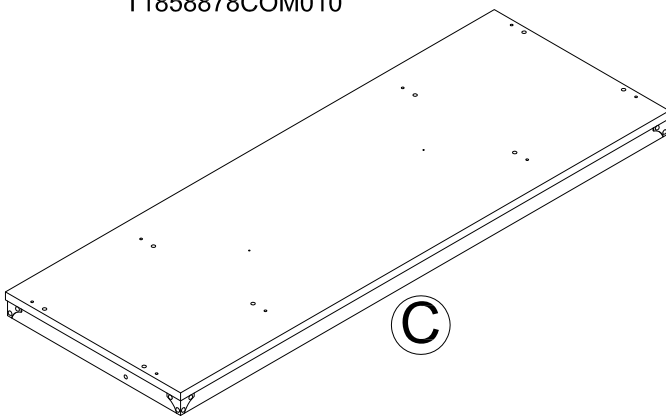

BOTTOM FRAME
T1858878COM030

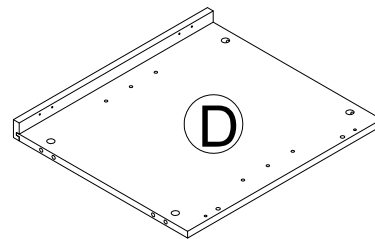

SIDE FRAME
T1858878COM040
QTY: 2 PCS

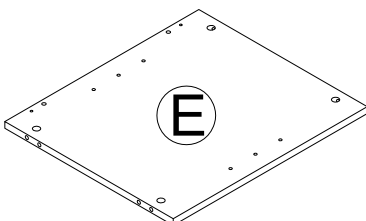

LEFT MIDDLE PANEL
T1858878COM050

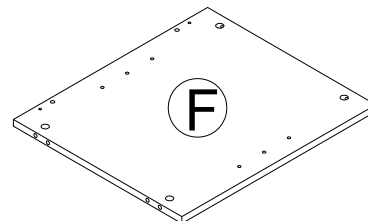

RIGHT MIDDLE PANEL
T1858878COM060

Board Identification

Not actual size

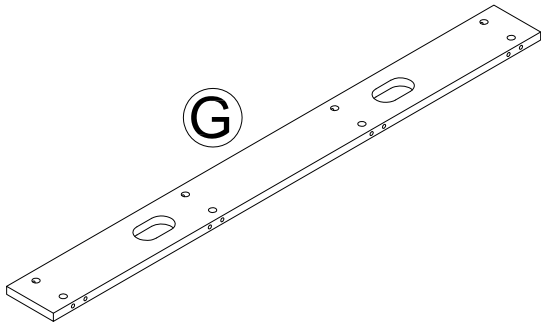

BACK PANEL
T1858878COM070

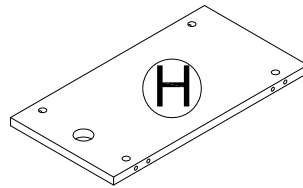

SIDE BACK PANEL
T1858878COM080
QTY: 2 PCS

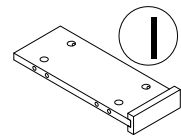

TOP SIDE PANEL
T1858878COM090
QTY: 2 PCS

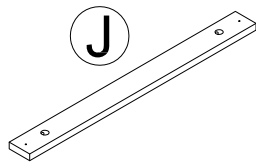

TOP SHELF APRON
T1858878COM100

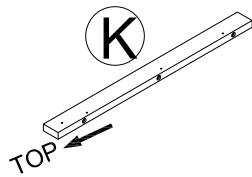

LEFT SIDE RAIL
T1858878COM110

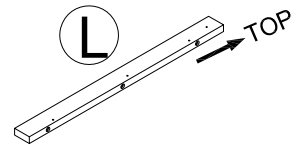

RIGHT SIDE RAIL
T1858878COM120

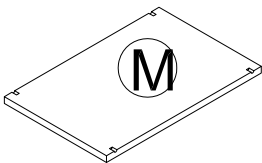

SIDE SHELF
T1858878COM130
QTY: 2 PCS

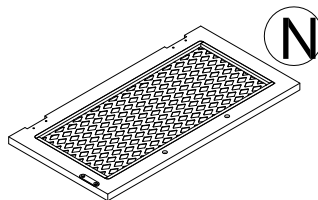

LEFT DOOR
T1858878COM140

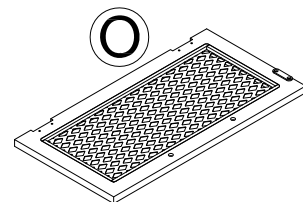

RIGHT DOOR
T1858878COM150

Part List

Not actual size

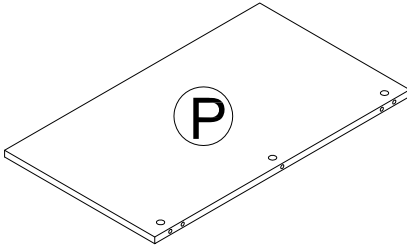

ADJUSTABLE SHELF
T1858878COM0160

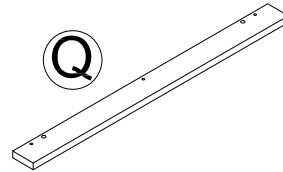

RIAL
T1858878COM170

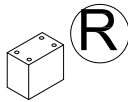

SUPPORTING PANEL
T1858878COM0180

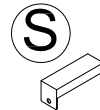

SUPPORTING PIPE
T1858878COM190
QTY: 2 PCS

Items included with 1865332COM only

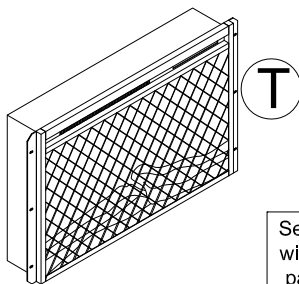

Fireplace
1859096COM
FA23V60L-8

See the manual came
with your fireplace insert for
part numbers and important
safety informaton

Part List

Not actual size

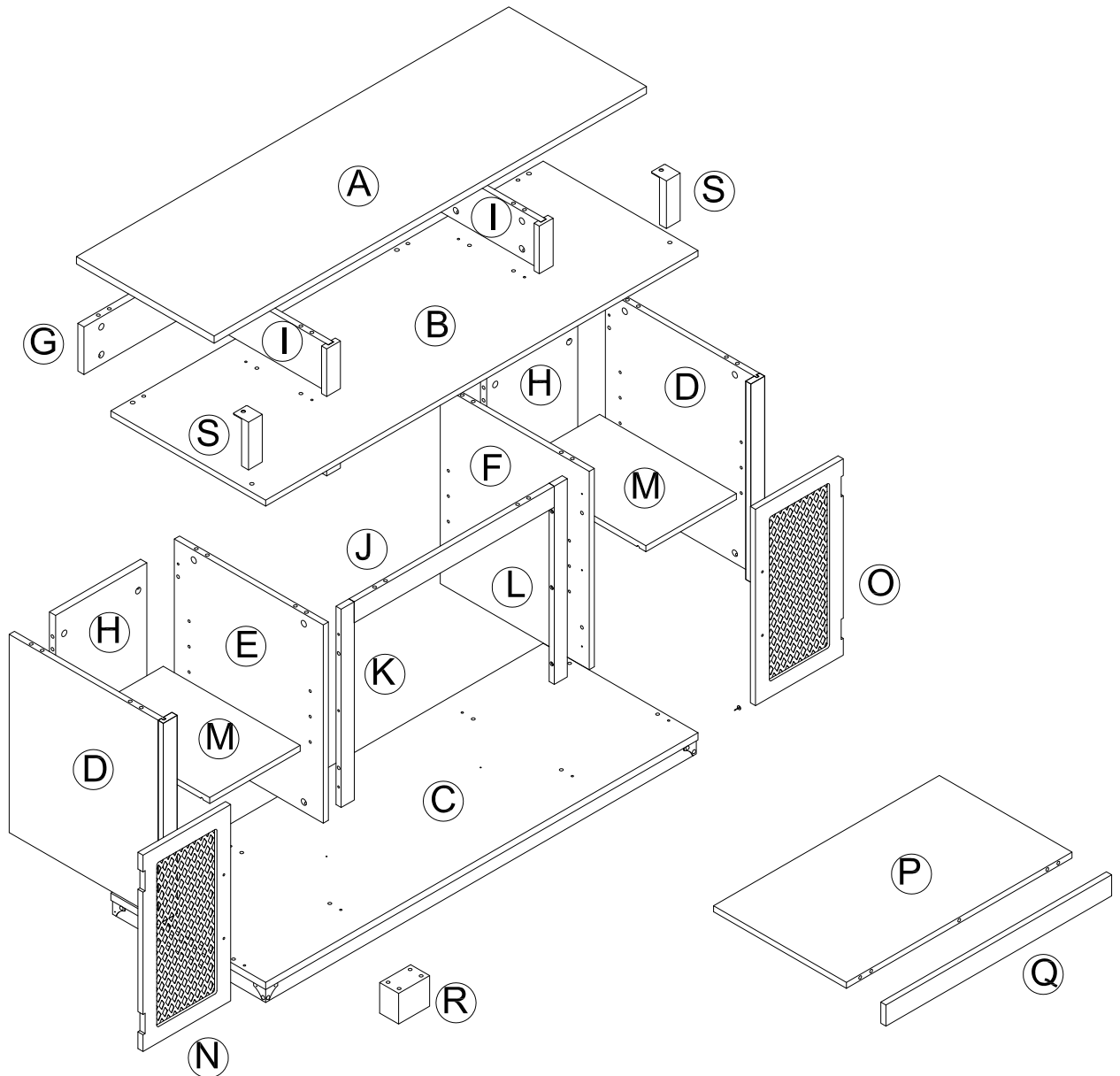

Part List

Actual Size

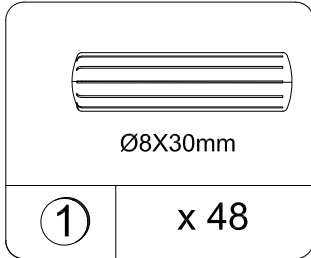

Wood dowel
TSF0501

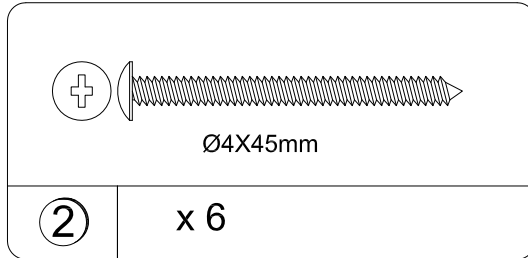

Screw
TSF1007

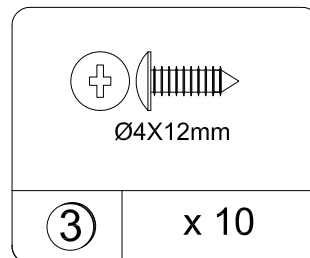

Screw
TSF1004

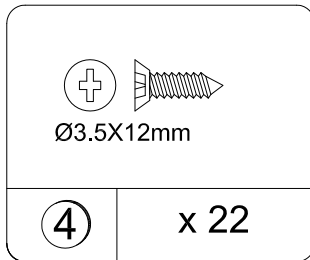

Screw
TSF0601

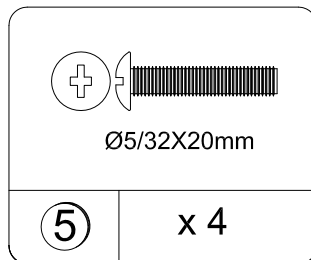

Screw bolt
TSF1811

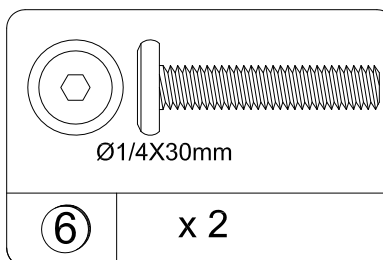

Bolt
TSF1403

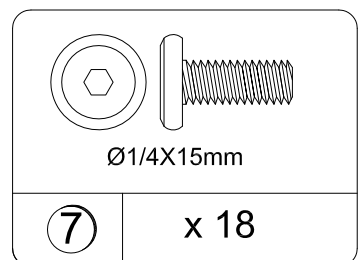

Bolt
TSF1404

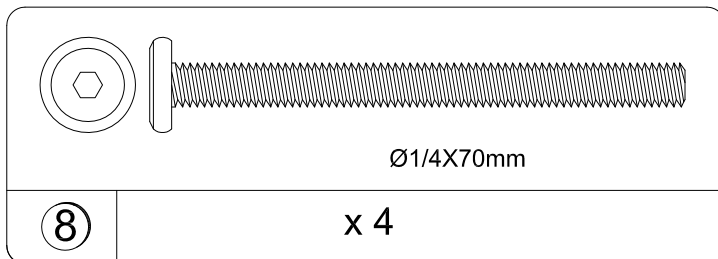

Bolt
TSF1422

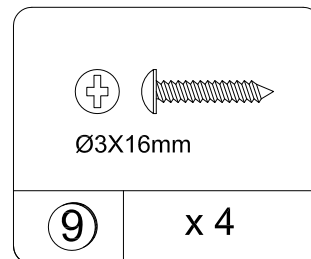

Screw
TSF1103

Part List

Not Actual Size

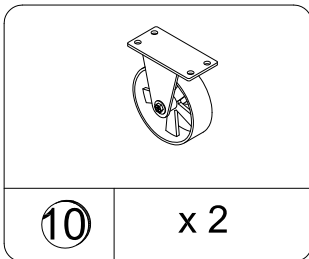

Caster
TSF4003

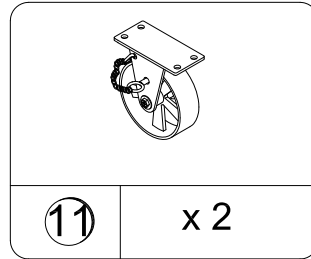

Caster With lock
TSF4004

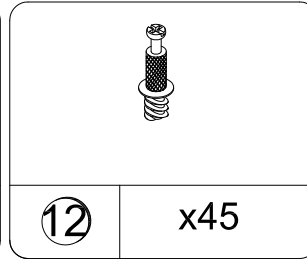

Cam bolt
TSF0354

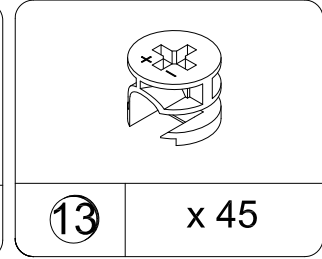

Cam lock
TSF0307

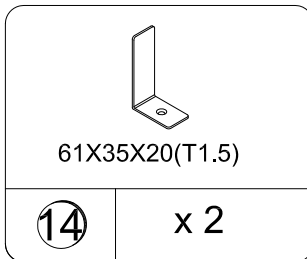

Angle Bracket
TSF0012

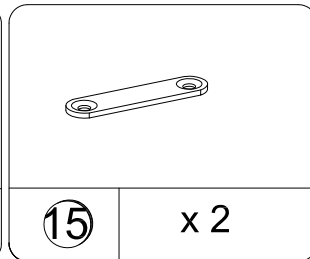

Washer
TSF2402

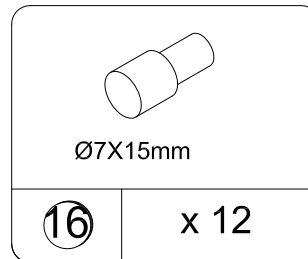

Shelf support
TSF0008

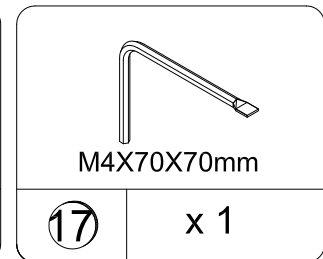

Hex key
TSF2804

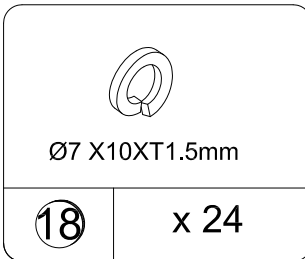

Spring washer
TSF2451

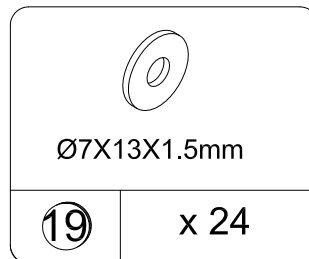

Washer
TSF2453

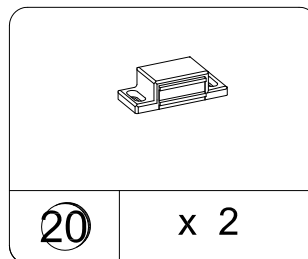

Magic catch
TSF0016

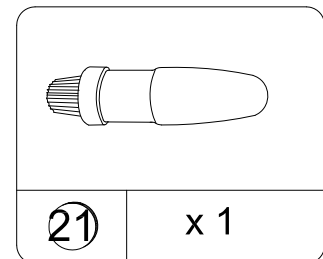

Glue
TSF0015

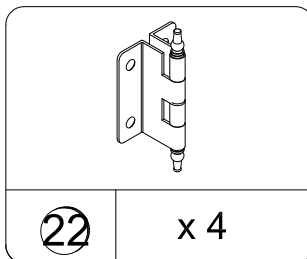

Hinge
TSF2705

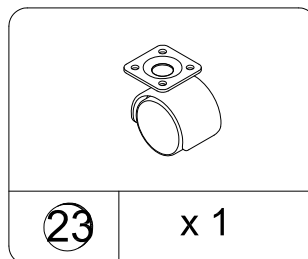

Caster With lock
TSF4008

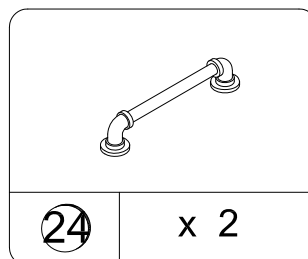

Knob
TSF2209



Warning label
TSF2909

STEP 1

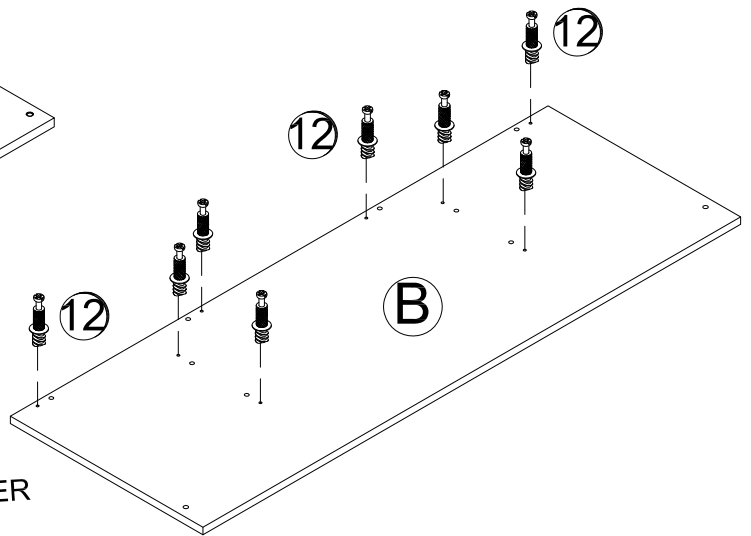
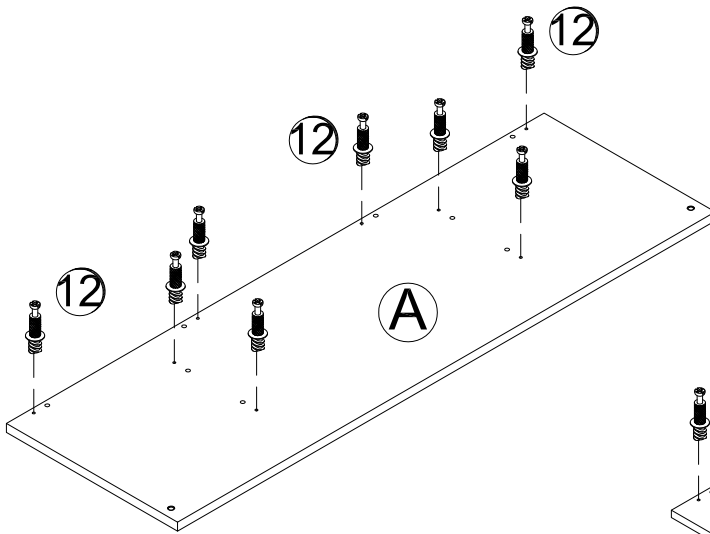
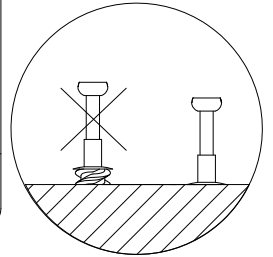
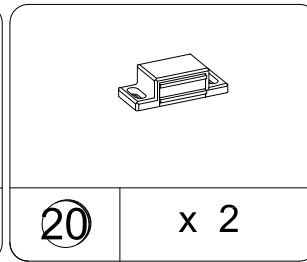
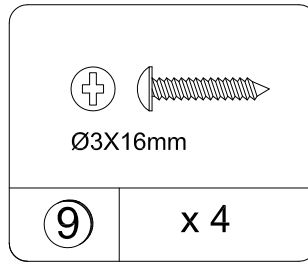
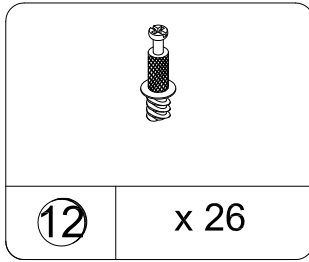
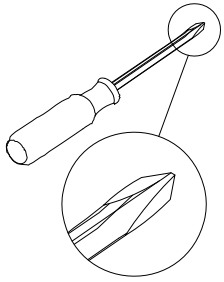

TURN OVER

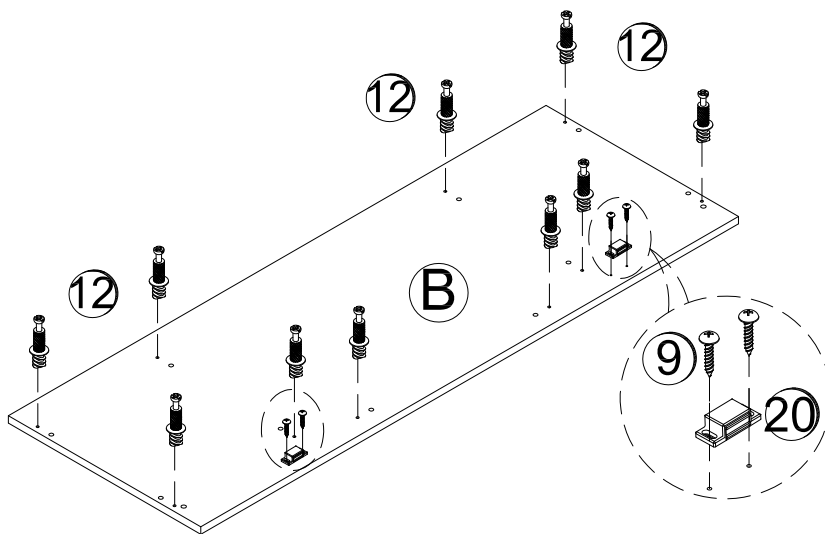

STEP 2

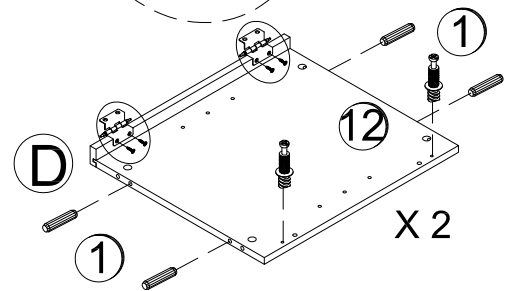
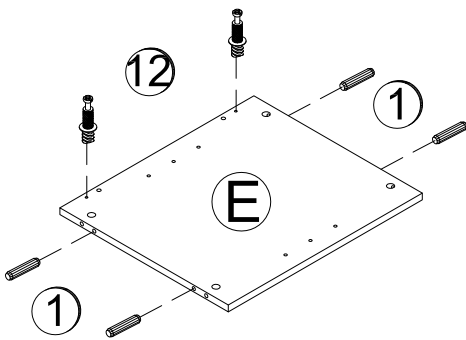
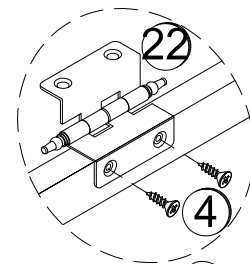
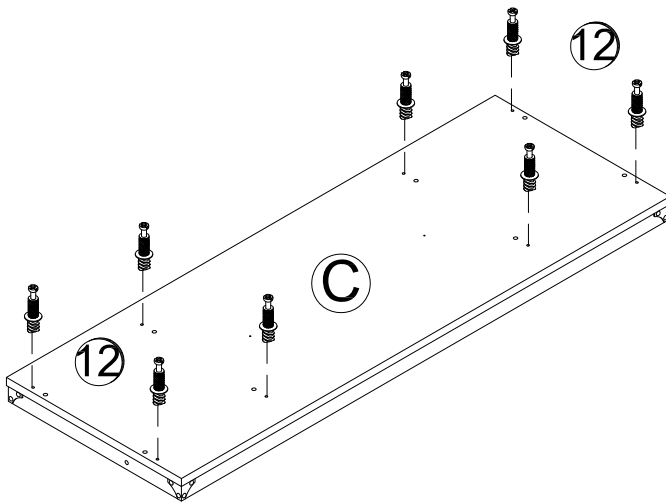
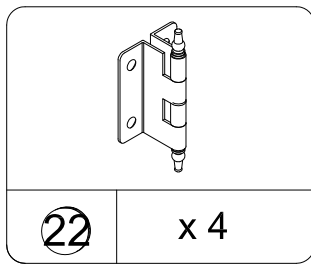
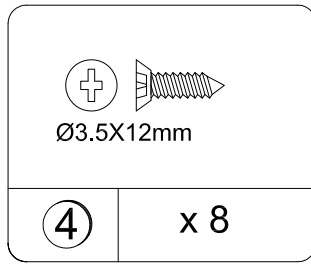
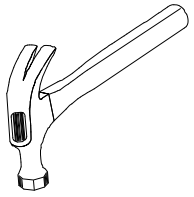
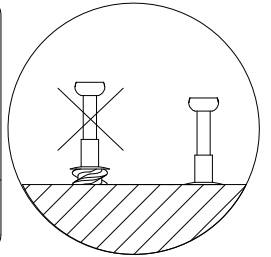
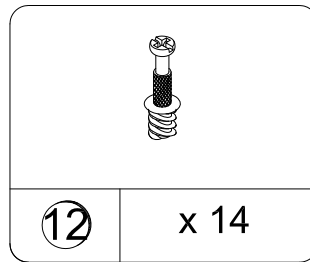
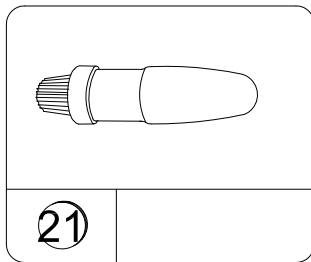
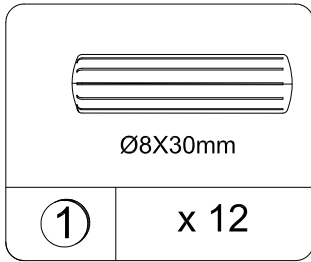
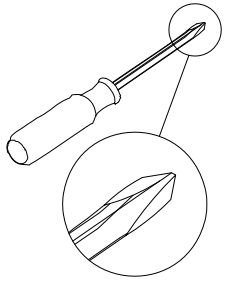

STEP 3

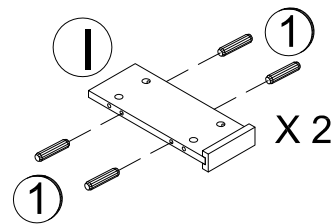
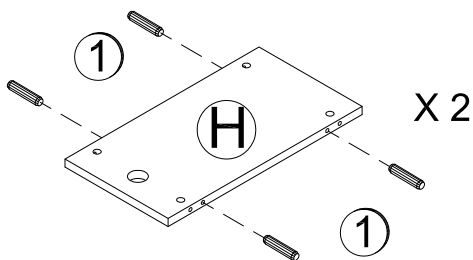
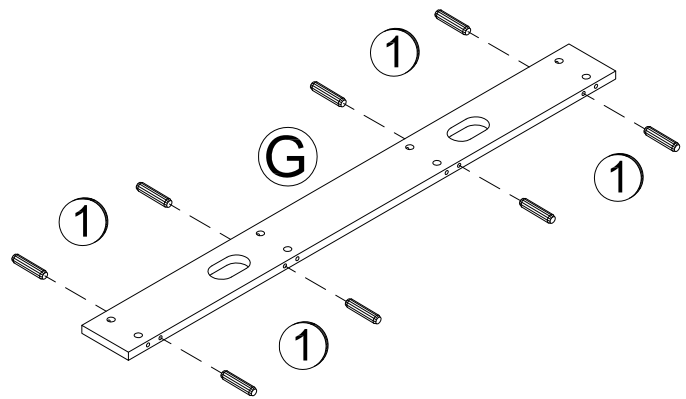
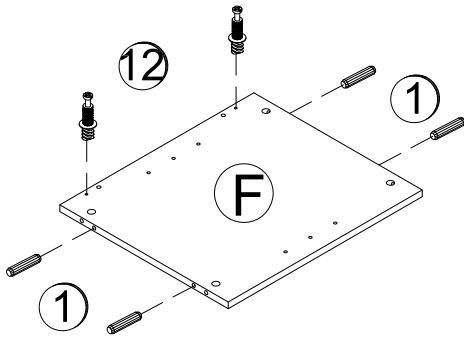
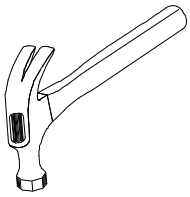
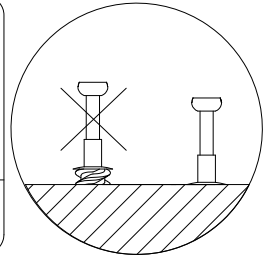
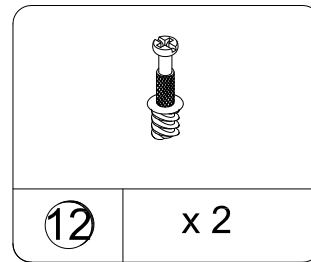
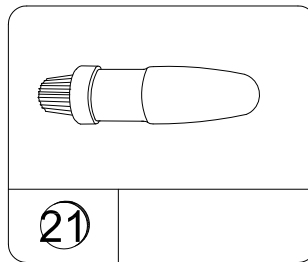
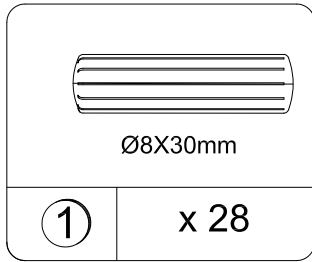
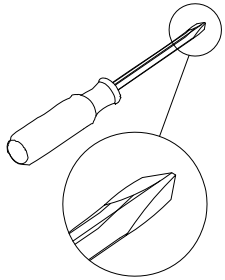

STEP 4

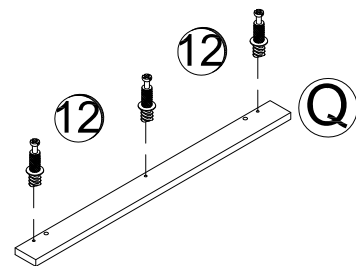
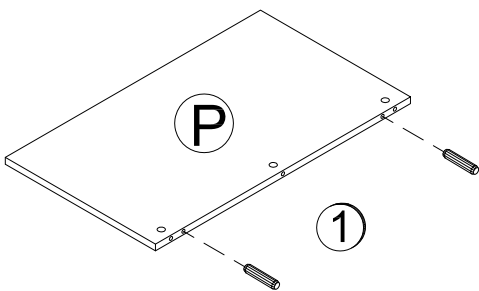
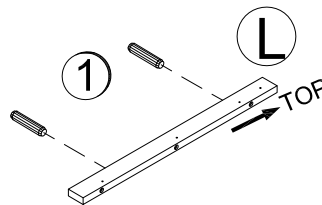
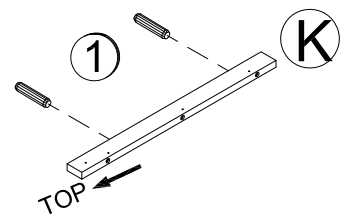
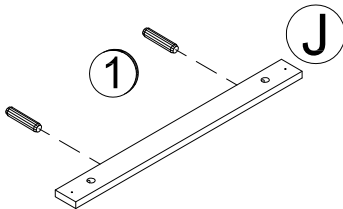
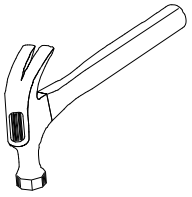
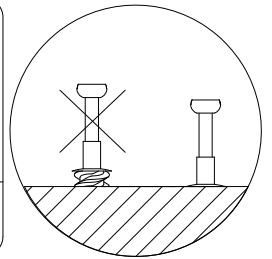
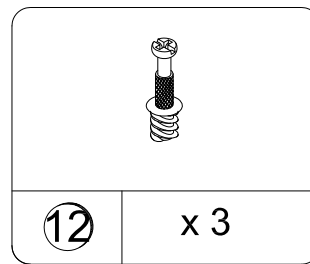
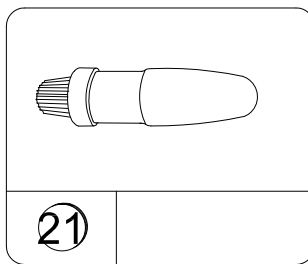
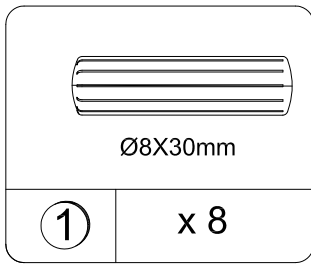
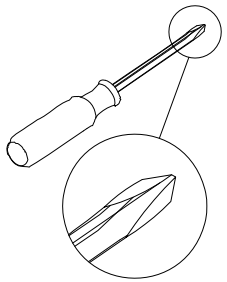

STEP 5

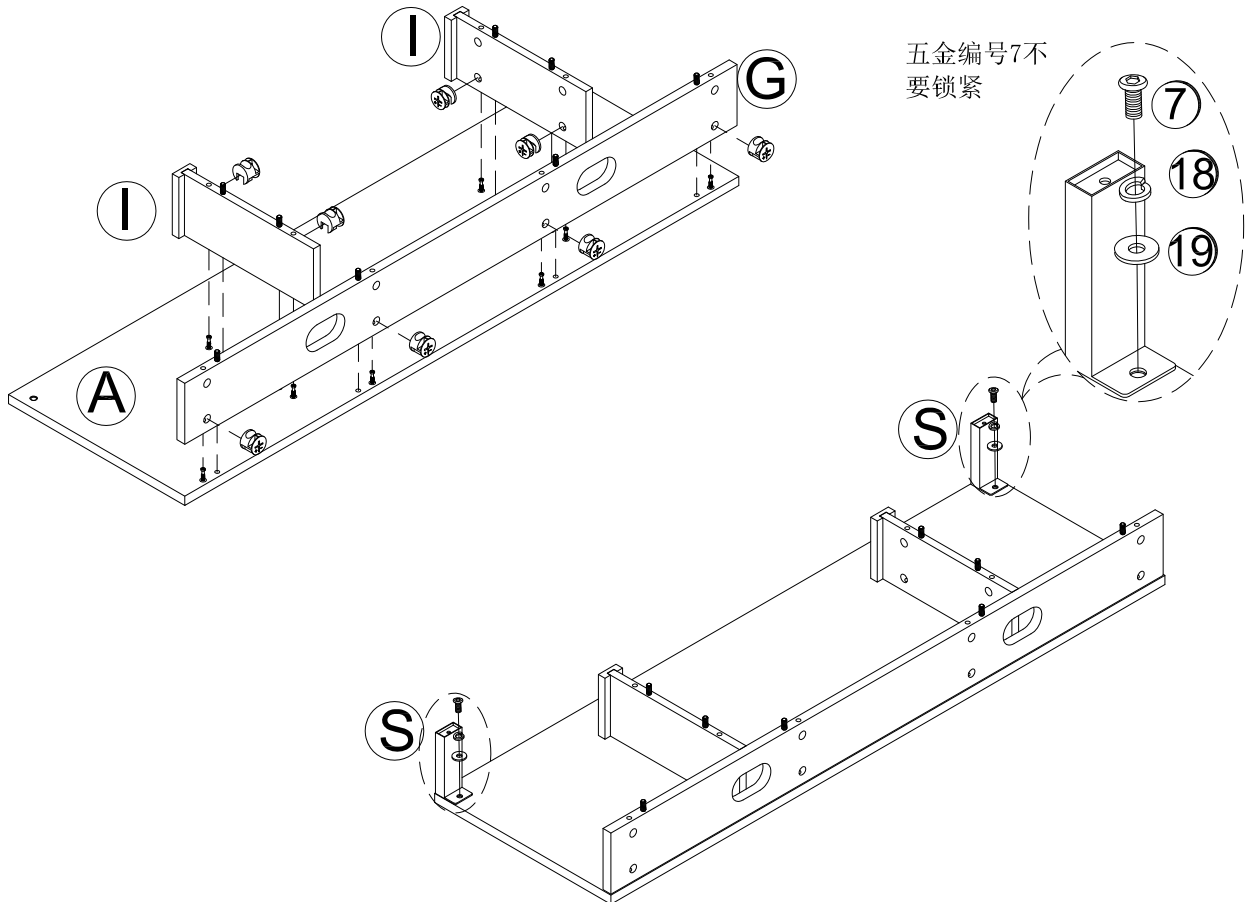
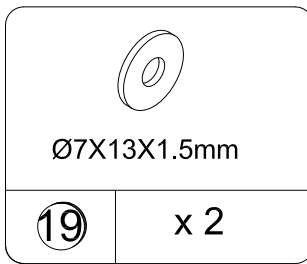
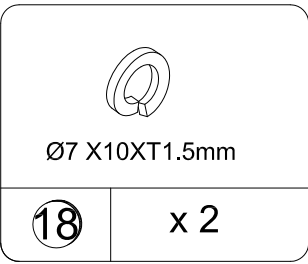
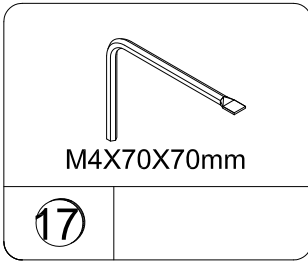
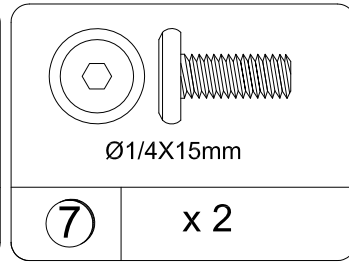
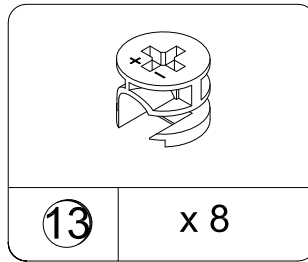
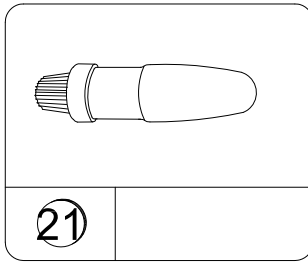
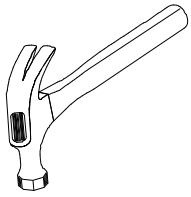
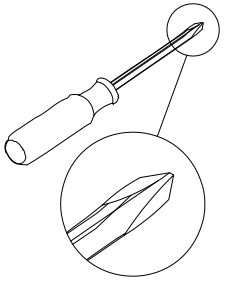

STEP 6

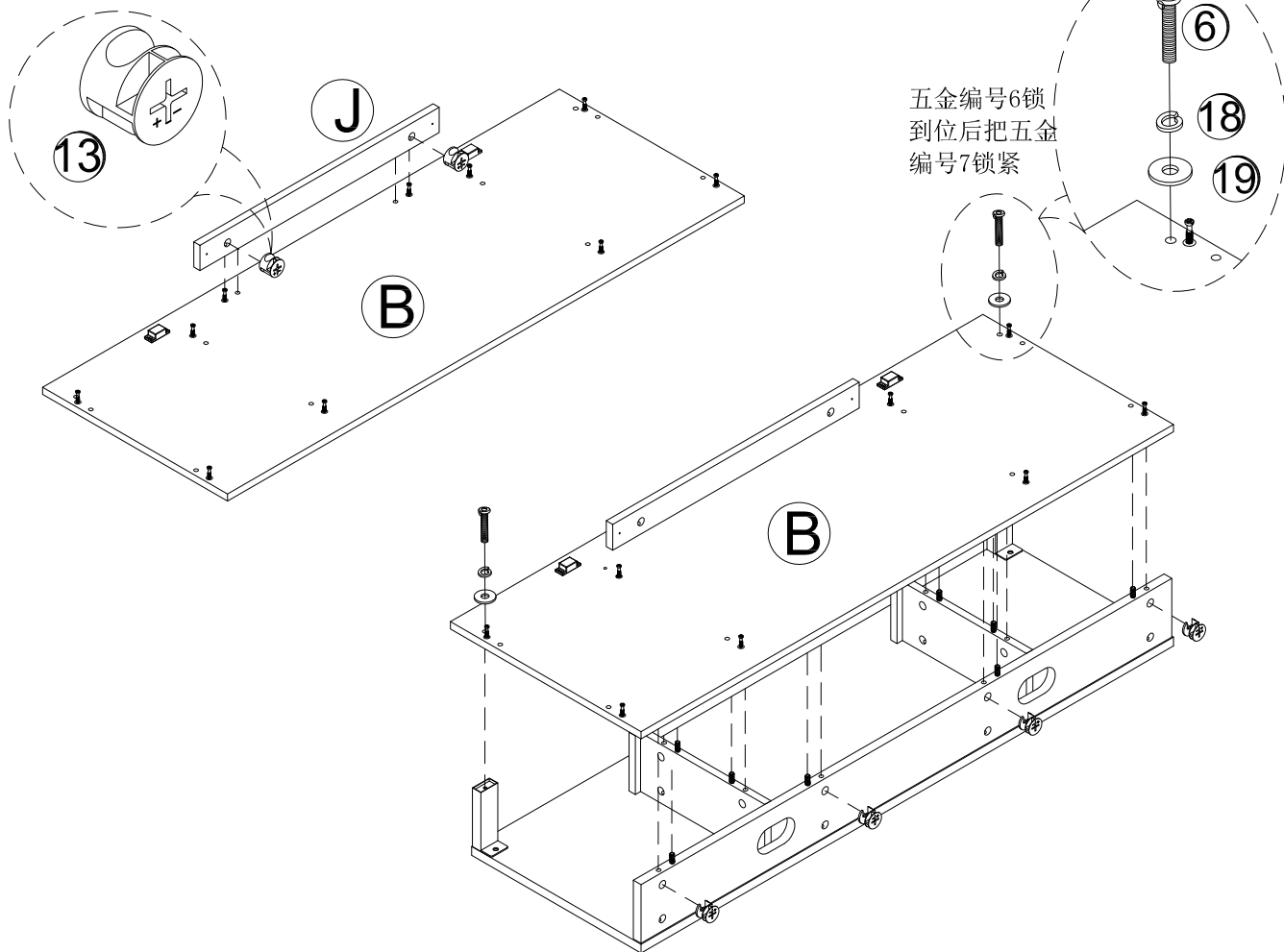
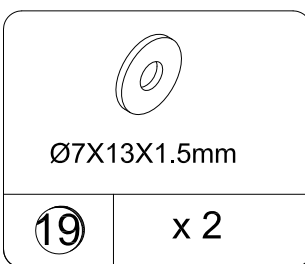
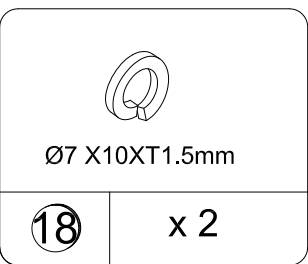
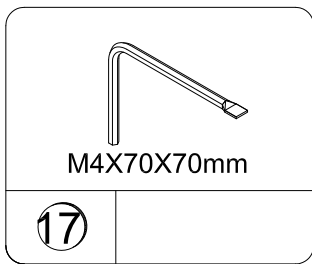
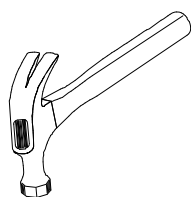
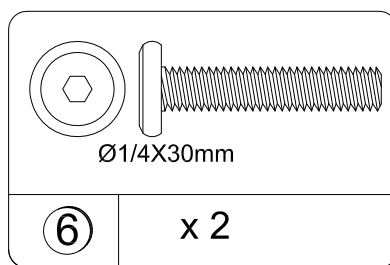
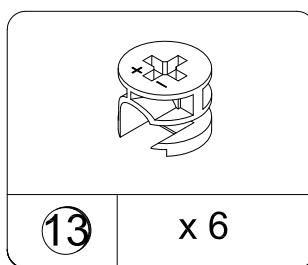
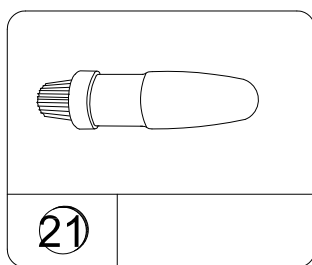
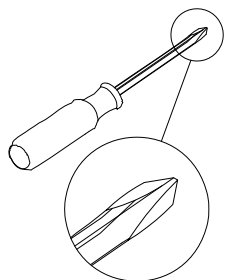

STEP 7

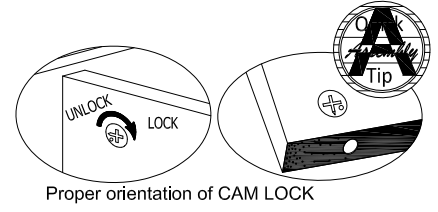
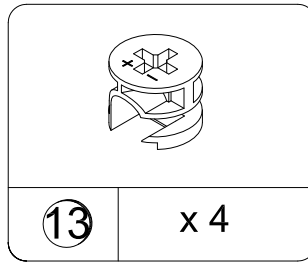
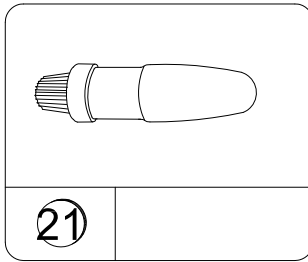
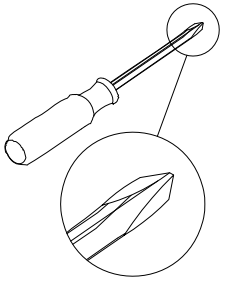

Proper orientation of CAM LOCK

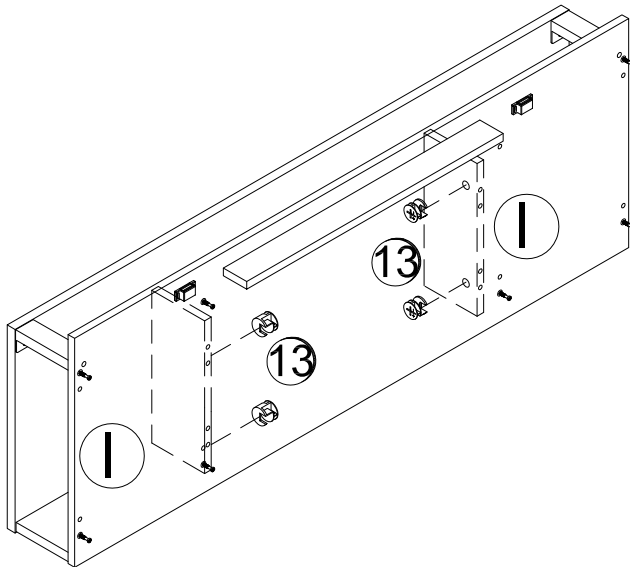
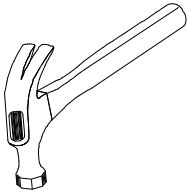

STEP 8

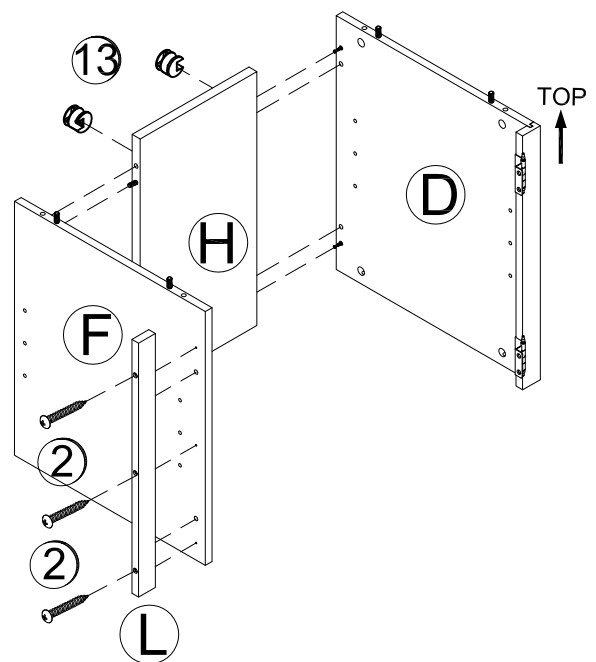
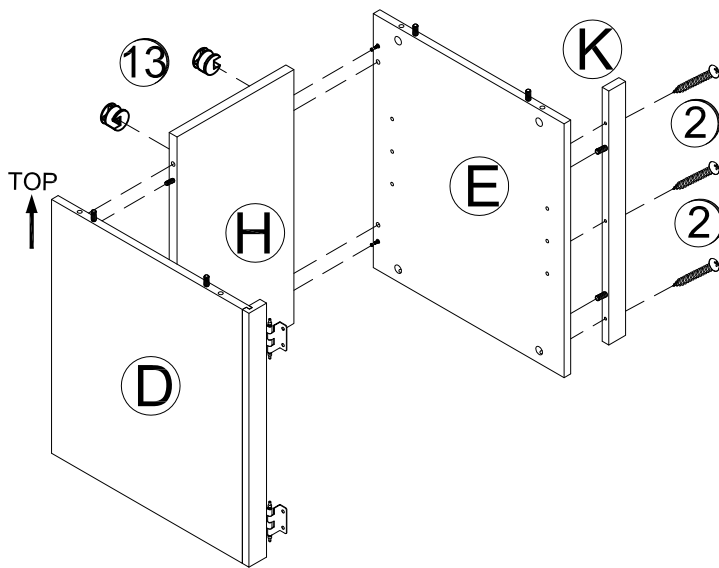
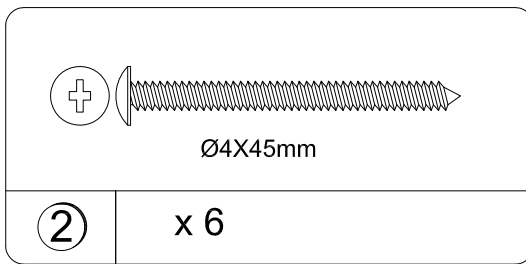
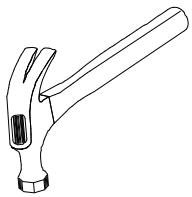
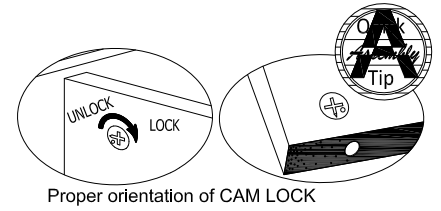
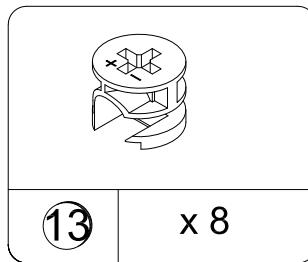
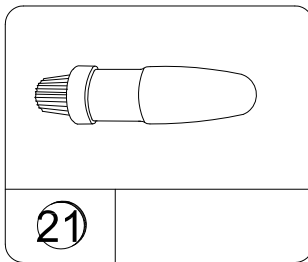
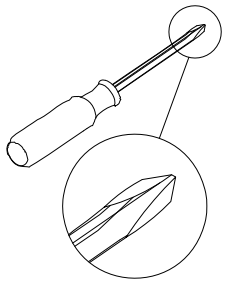

STEP 9

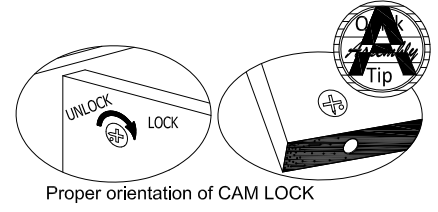
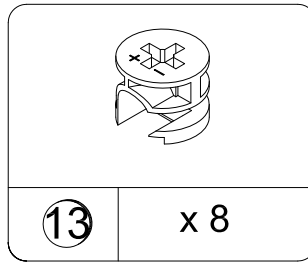
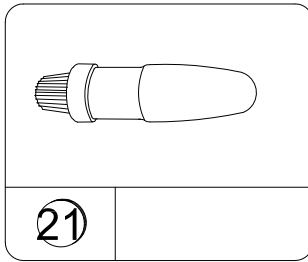
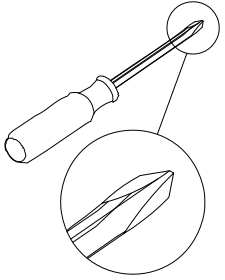

Proper orientation of CAM LOCK

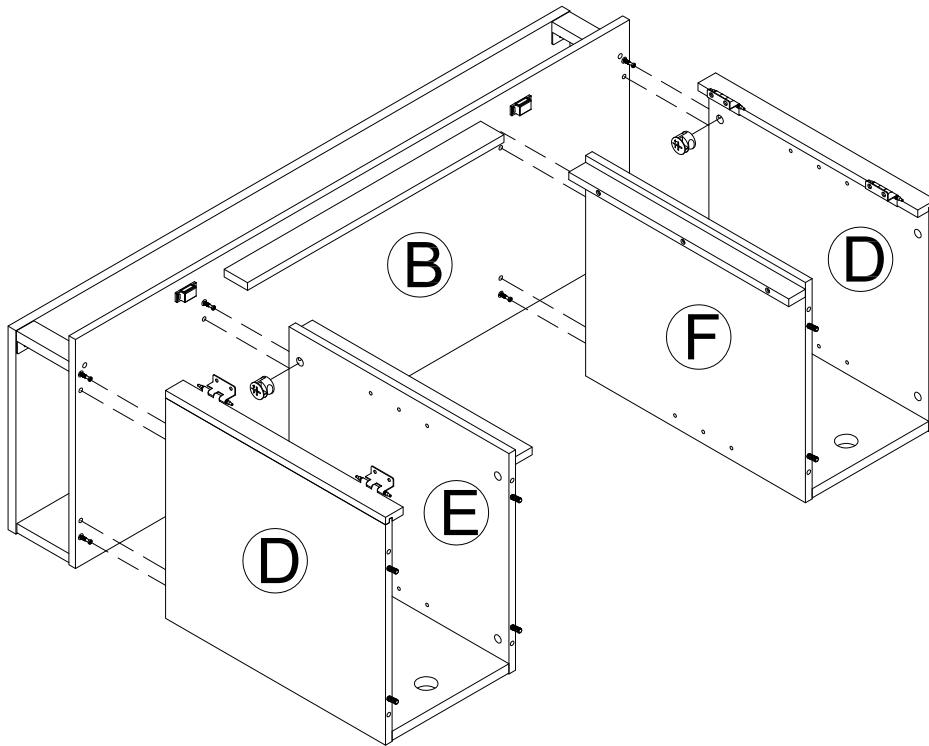

STEP 10

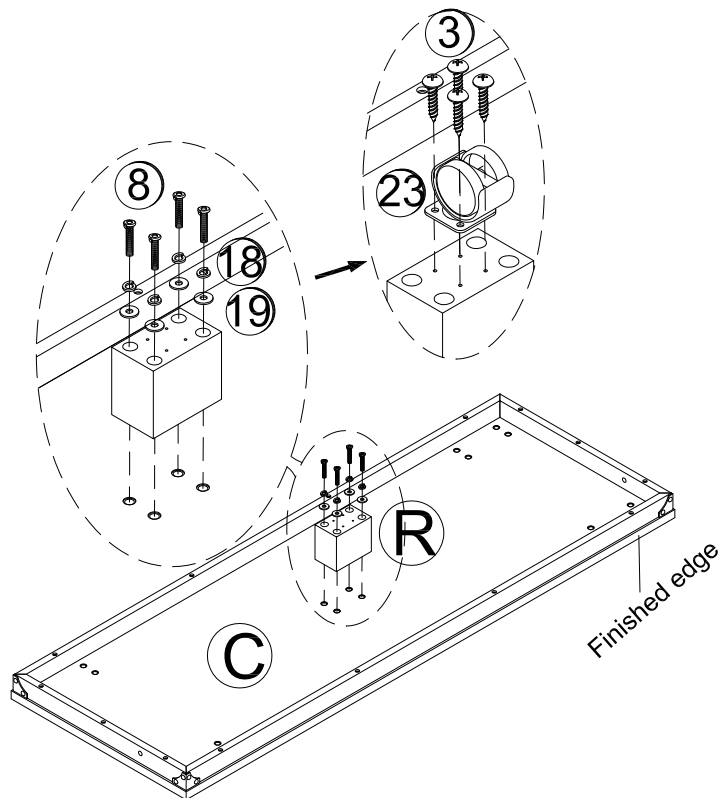
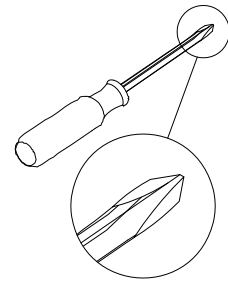
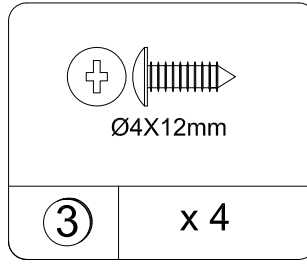
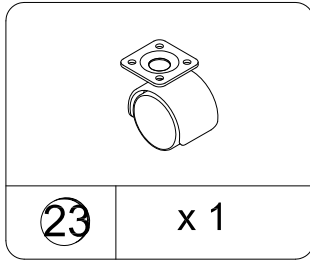
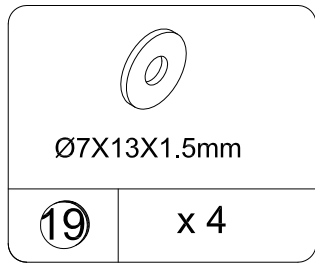
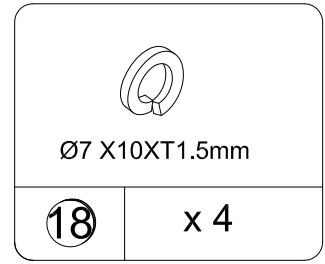
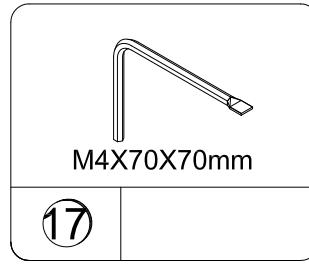
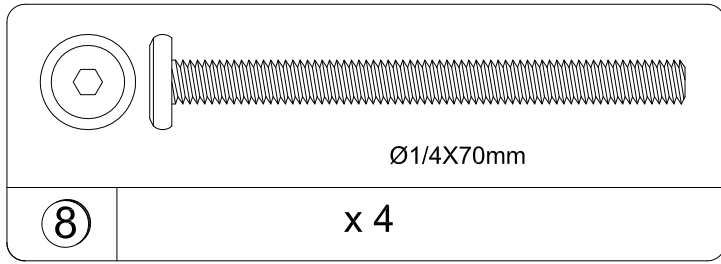

STEP 11

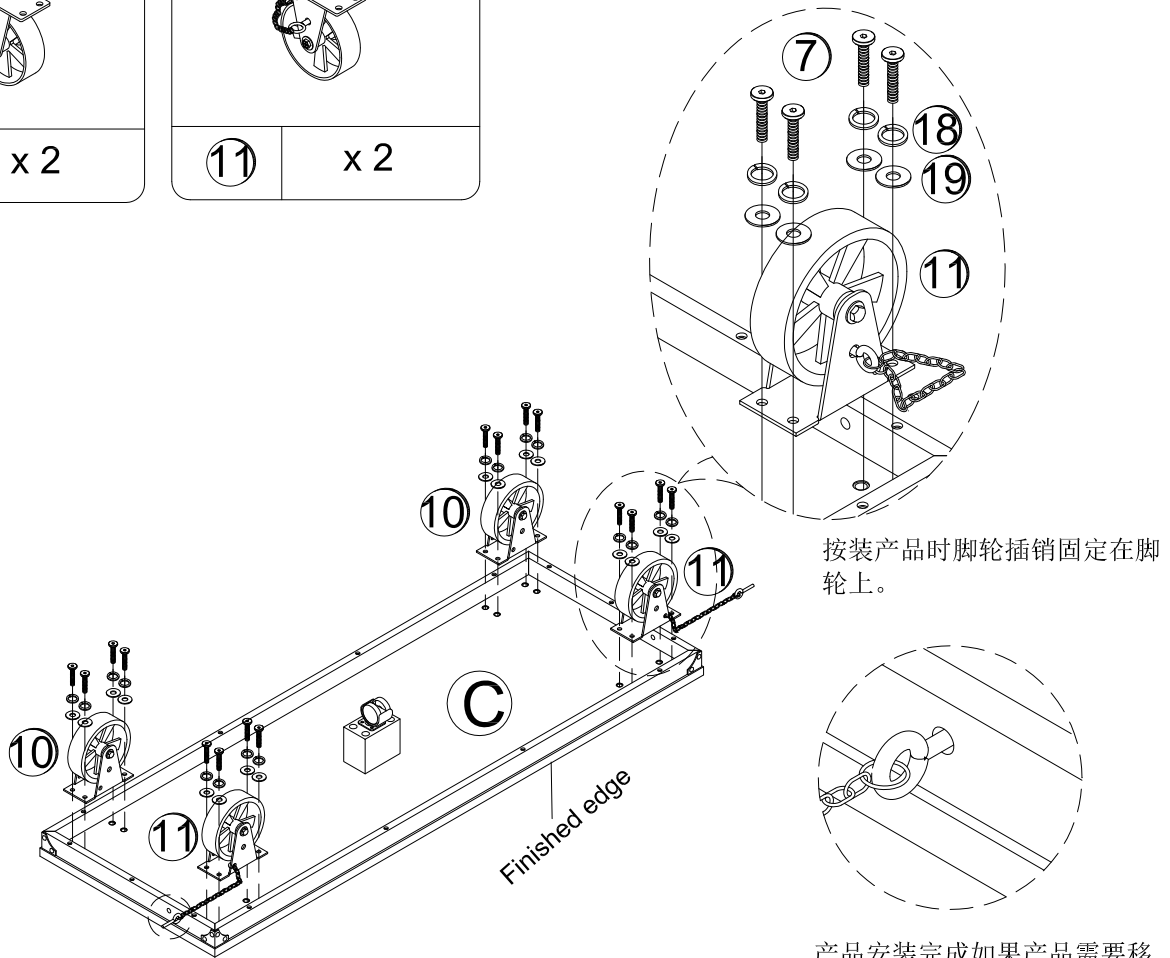
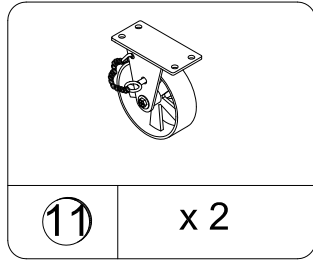
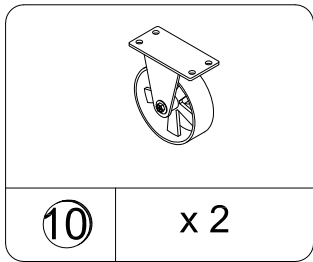
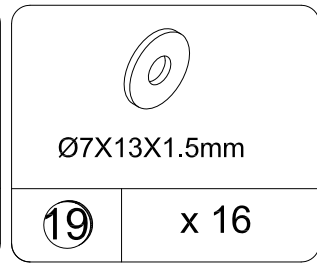
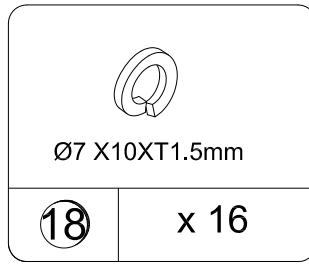
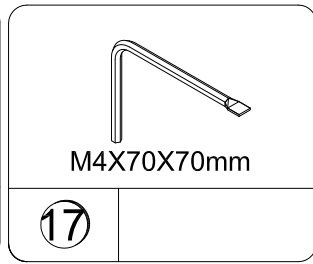
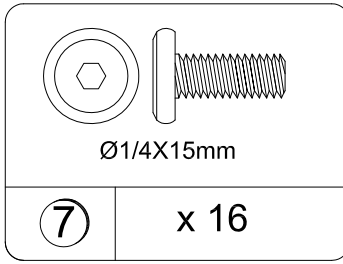

STEP 12

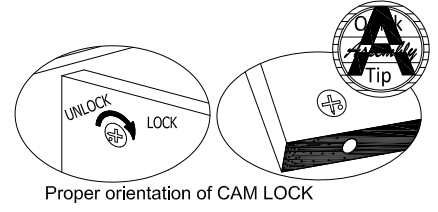
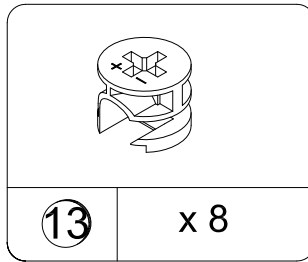
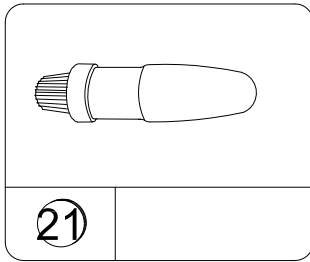
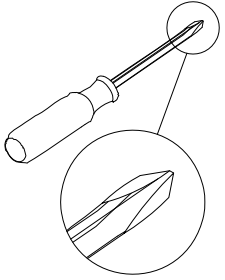

Proper orientation of CAM LOCK

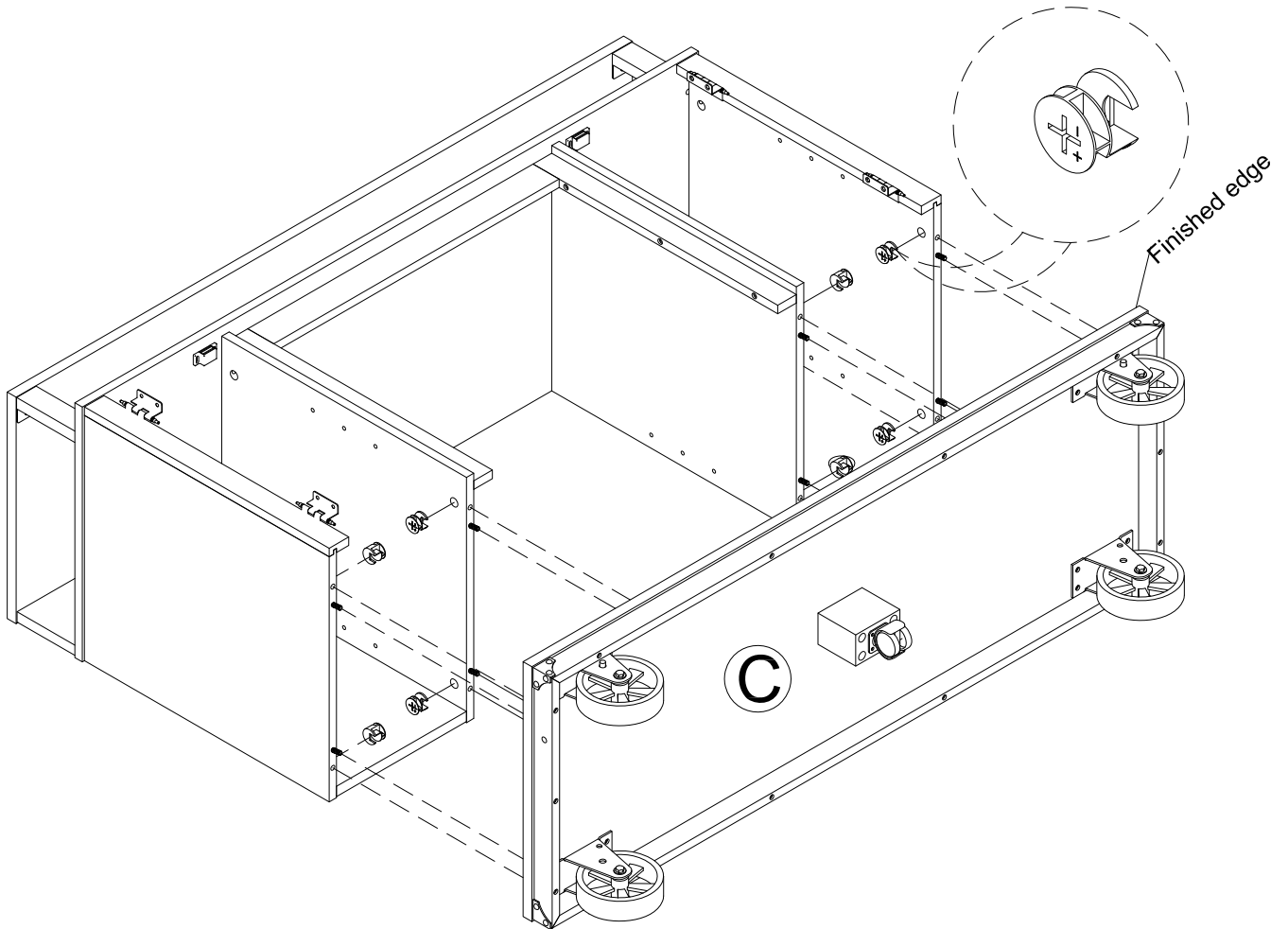



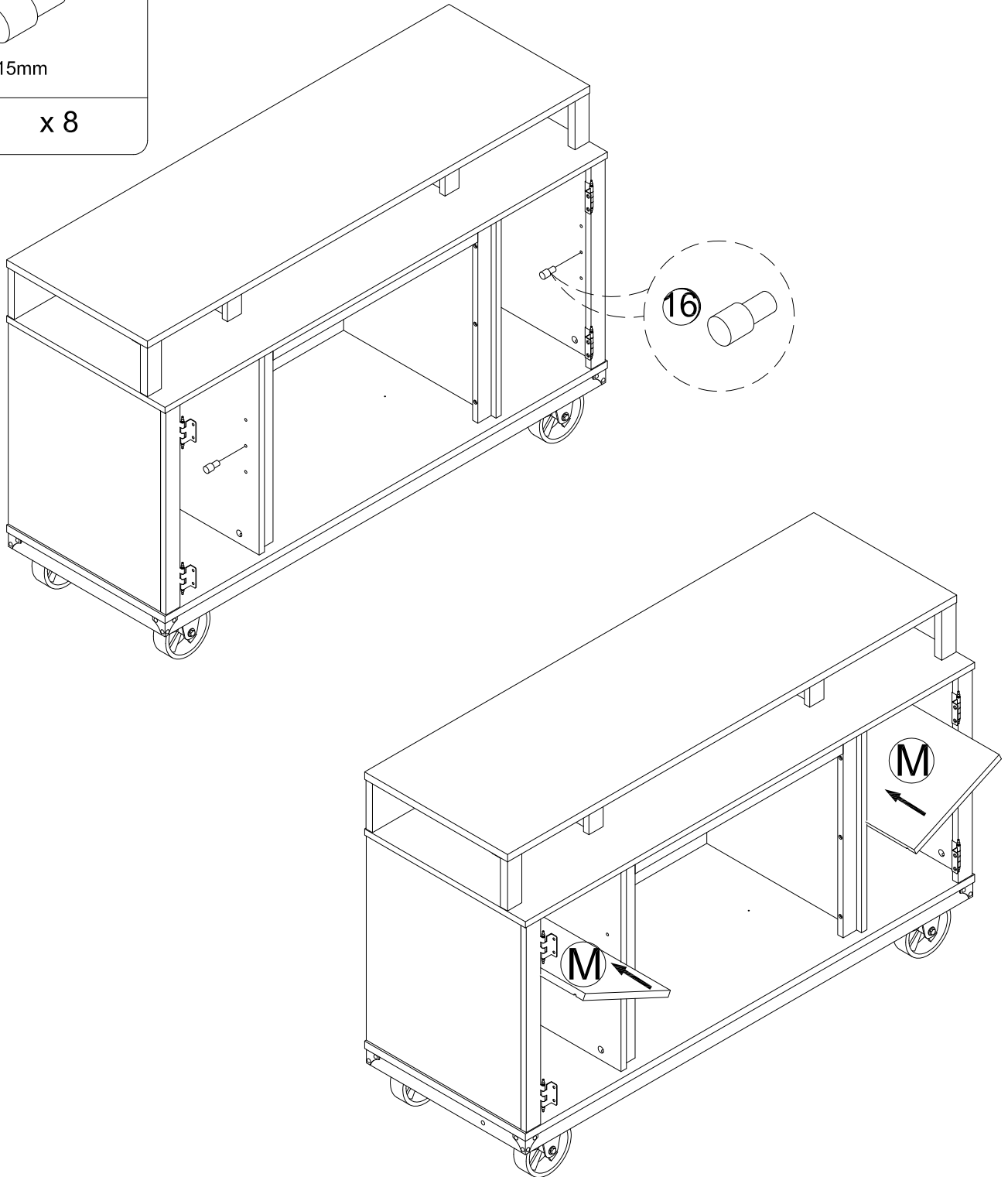
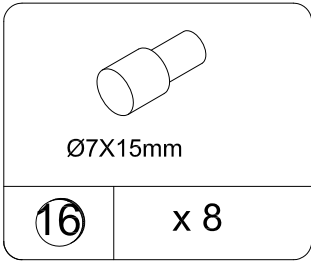

STEP 13

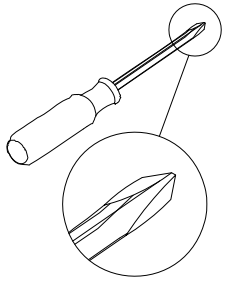

STEP 14



 Ø3.5X12mm	
④	x 8

 Ø5/32X20mm	
⑤	x 4

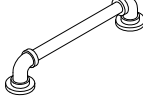
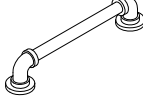
	
②④	x 2

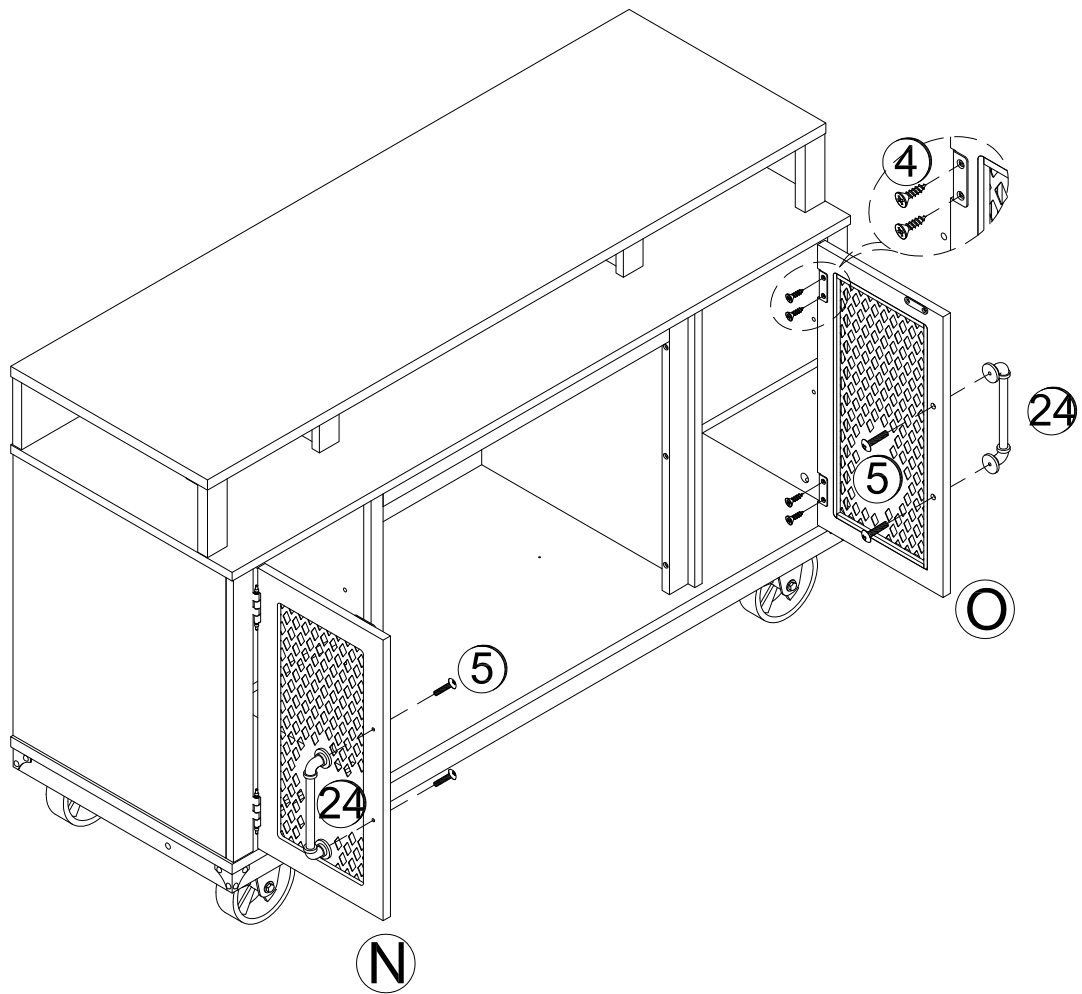

STEP 15

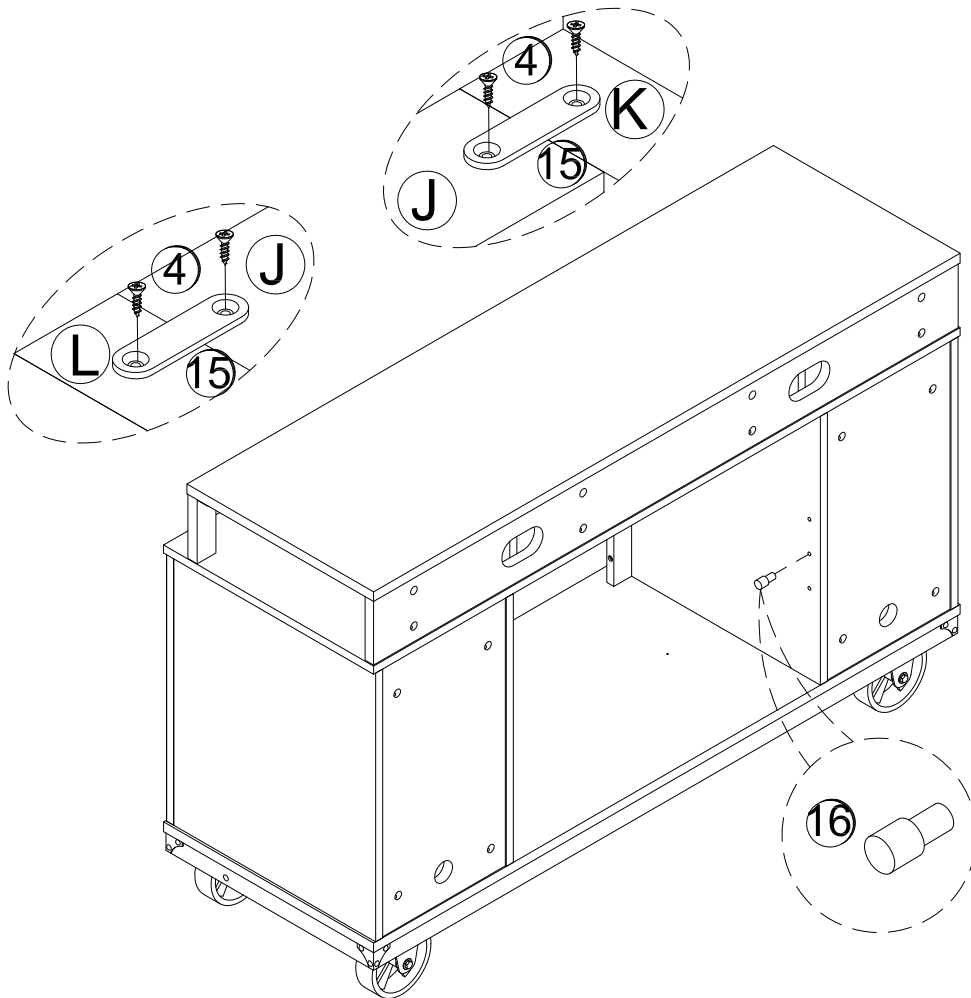
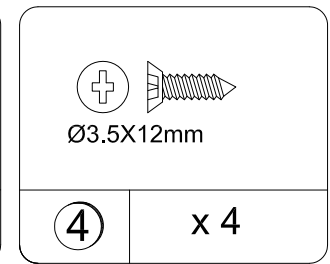
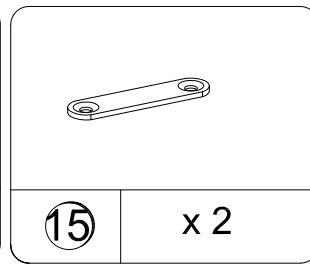
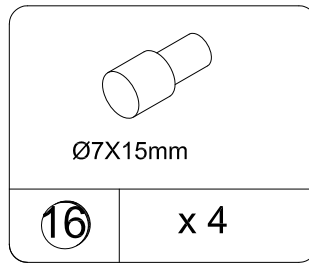
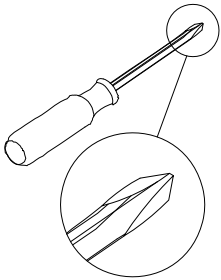

If you purchased the 1866878COM with the fireplace insert, skip this step and proceed to step 16.

STEP 16

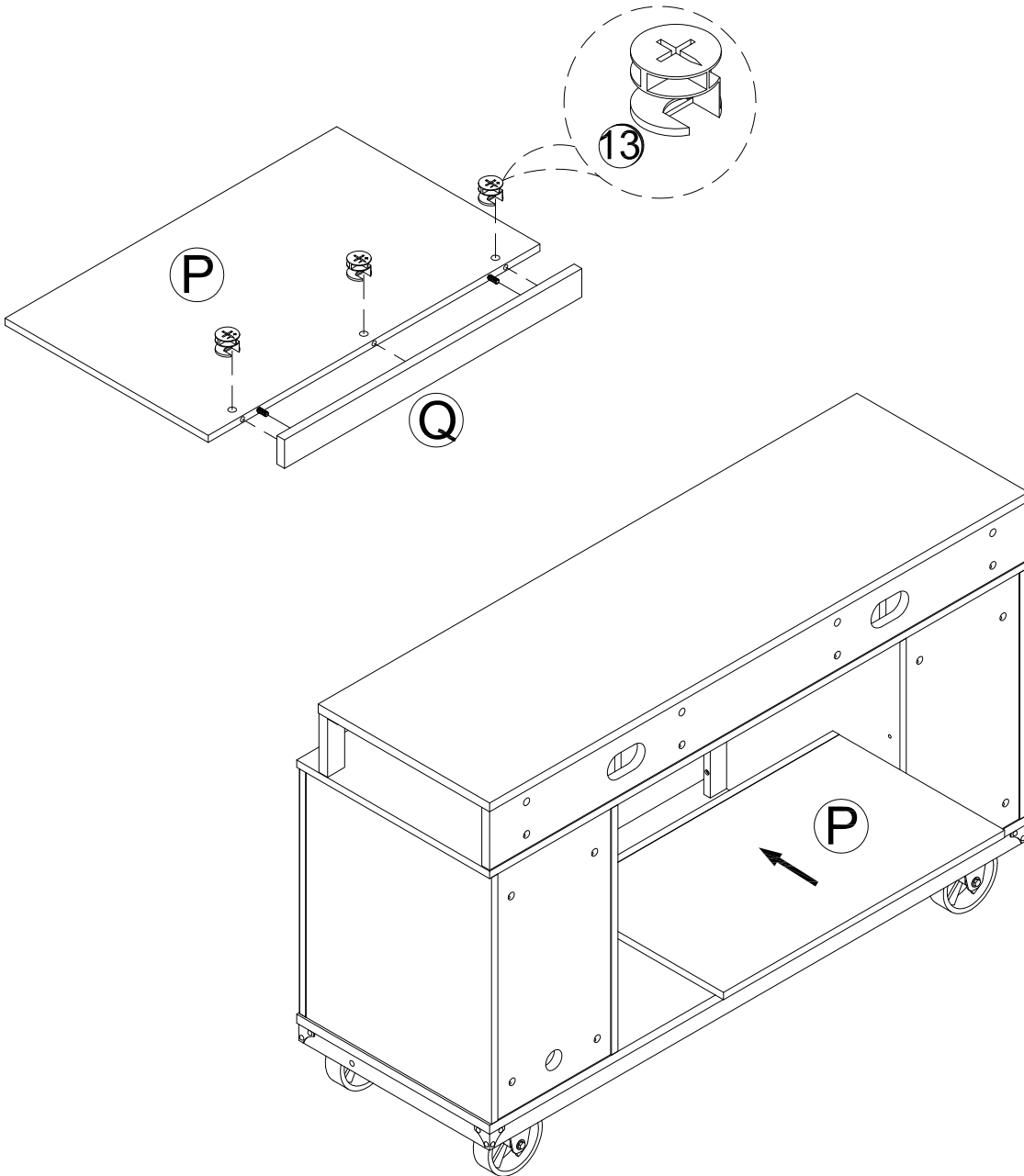
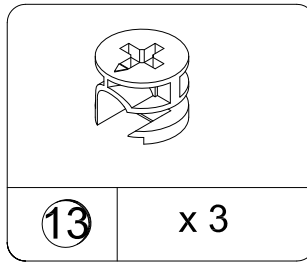
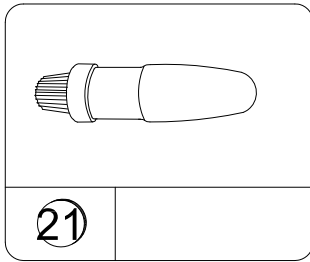
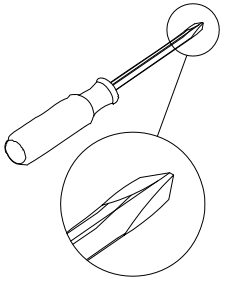

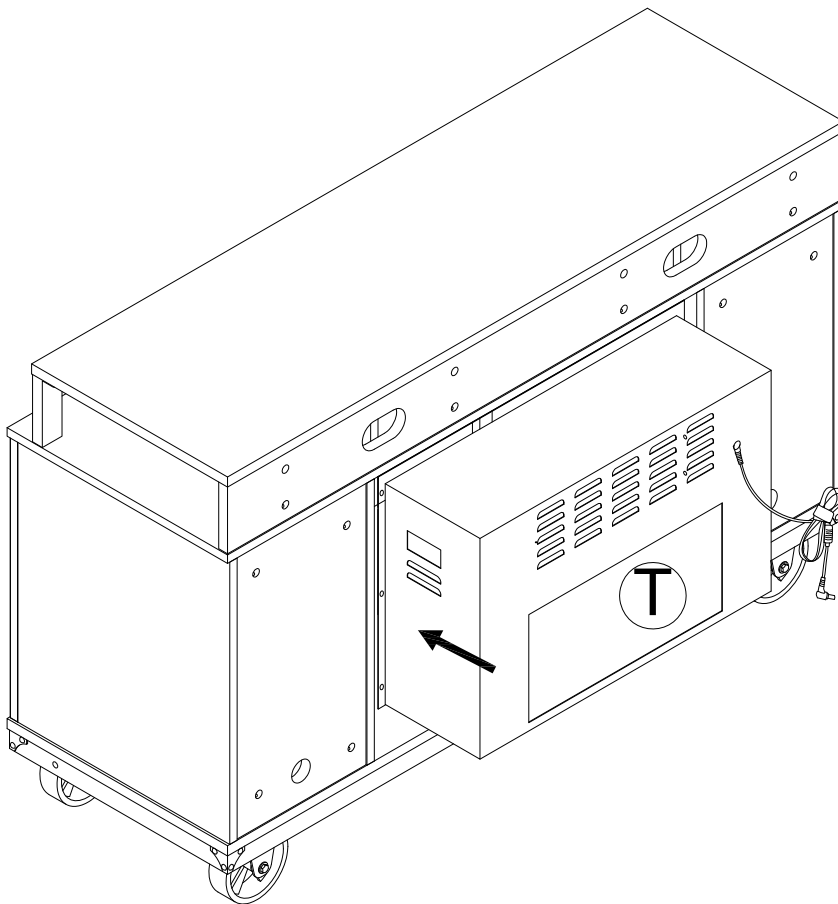

STEP 17

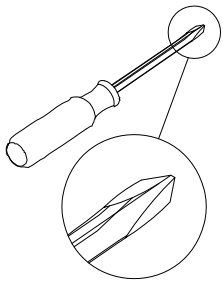

STEP 18



 Ø4X12mm	
3	x 6

 Ø3.5X12mm	
4	x 2

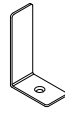
 61X35X20(T1.5)	
14	x 2

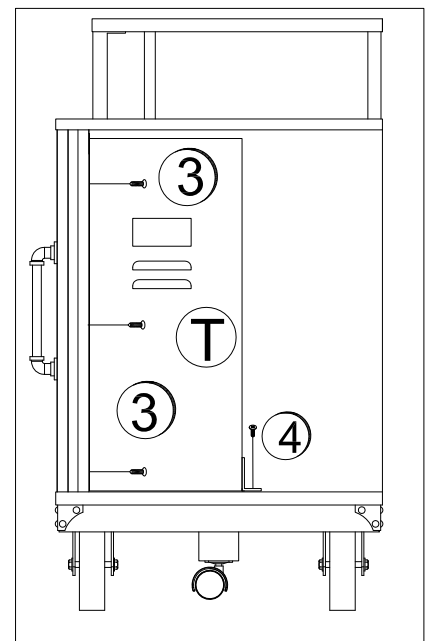
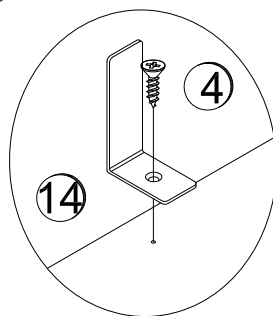
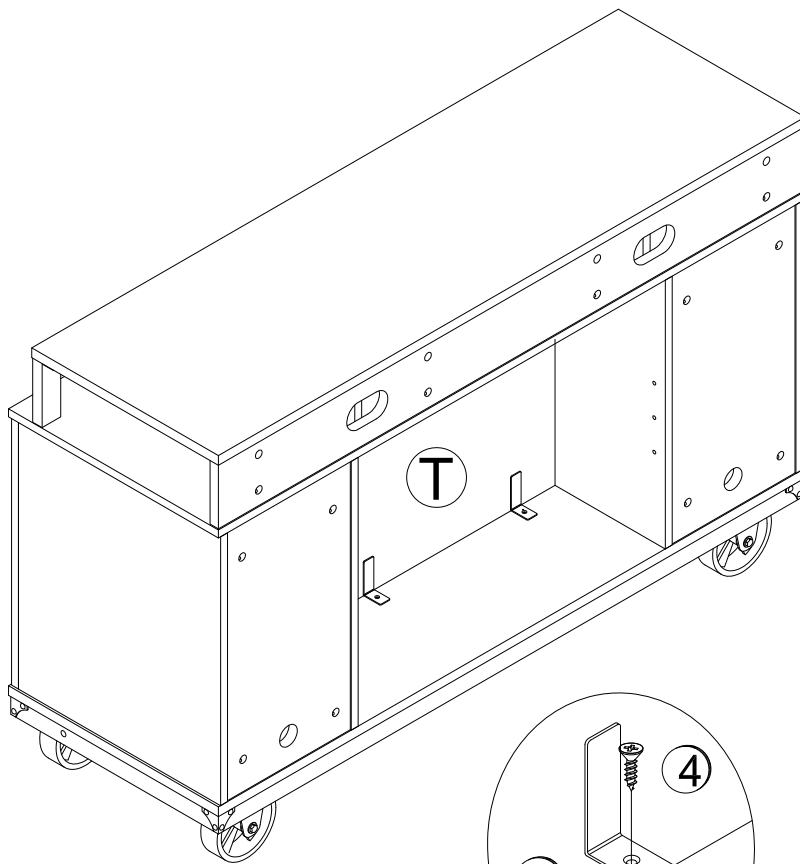

(SIDE VIEW)

STEP 19

BEFORE CONNECTING THE UNIT TO A WALL ELECTRIC OUTLET

Please carefully read and follow instructions and safety warnings in “Fireplace Homeowners Operating Manual” to operate your fireplace.

WARNING

IF THE INFORMATION IN THE
FIREPALCE OPERATING MANUAL
IS NOT FOLLOWED, AN ELECTRIC
SHOCK OR FIRE MAY RESULT IN
PROPERTY DAMAGE, PERSONAL
INJURY , OR LOSS OF LIFE .

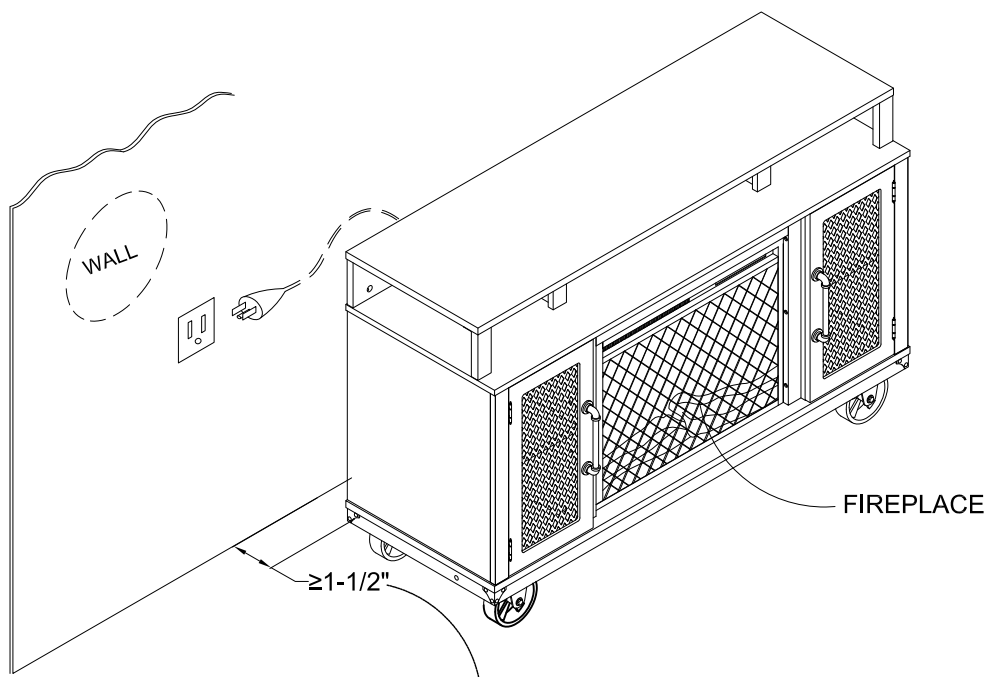

To allow proper heater ventilation, this unit must be located a minimum of 1-1/2” away from a back wall.

Maximum Loads

This unit has been designed to support the maximum loads shown. Exceeding these load limits could cause sagging, instability, product collapse, and/or serious injury.

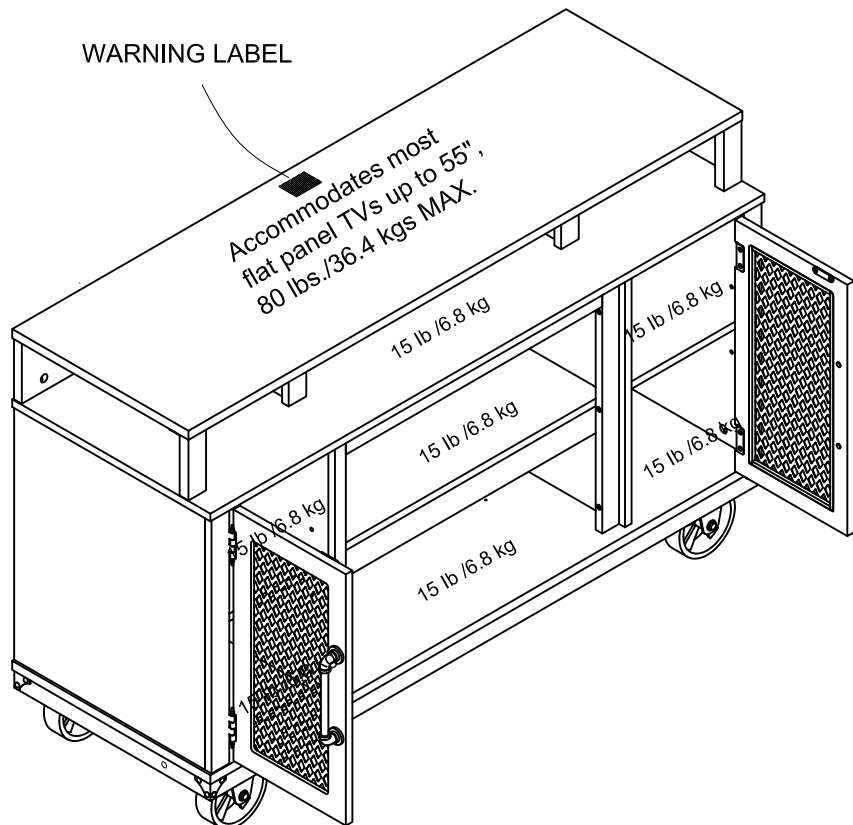

Apply the warning label to the center of the top panel as shown, ensure the TV covers the label in use. You will not be able to remove the label after it is applied to the top panel.

Certificate of Conformity

1. This certificate applies to the Dorel Home Furnishings, Inc. product identified by this instruction manual.
2. This certificate applies to compliance of this product with the CPSC Ban on Lead-Containing Paint (16 CFR 1303).
3. This product is distributed by: Dorel Home Furnishings, Inc.
410 East First Street South
Wright City, MO 63390
636-745-3351
4. Site of Manufacture: Fujian China
5. See front page of instruction manual for date of manufacture.

Maximum Loads

This unit has been designed to support the maximum loads shown. Exceeding these load limits could cause sagging, instability, product collapse, and/or serious injury.

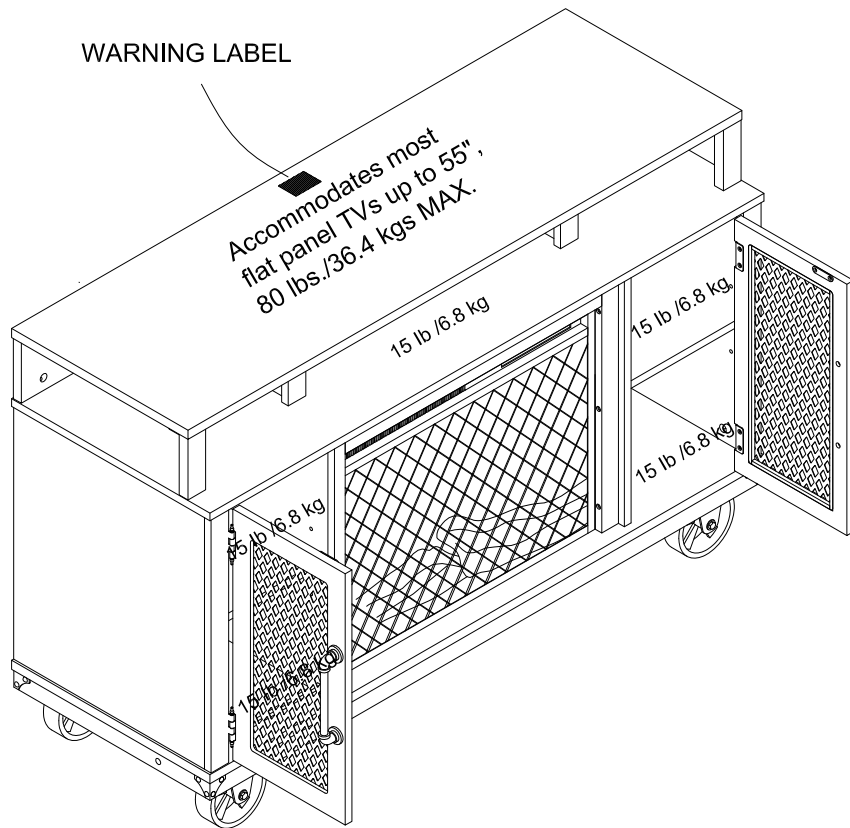

Apply the warning label to the center of the top panel as shown, ensure the TV covers the label in use. You will not be able to remove the label after it is applied to the top panel.

Certificate of Conformity

1. This certificate applies to the Dorel Home Furnishings, Inc. product identified by this instruction manual.
2. This certificate applies to compliance of this product with the CPSC Ban on Lead-Containing Paint (16 CFR 1303).
3. This product is distributed by: Dorel Home Furnishings, Inc.
410 East First Street South
Wright City, MO 63390
636-745-3351
4. Site of Manufacture: Fujian China
5. See front page of instruction manual for date of manufacture.

Register your product to receive the following:



- * New trend details - sneak peek on what's new
- * Surveys - have a voice within our community
- * Exclusive deals and discount codes
- * Quick and easy replacement part service

To register your product, visit ameriwoodhome.com



Visit your local retailer's website, rate your purchased product and leave us some feedback!

We would like to extend a big "Thank You" to all of our customers for taking the time to assemble this Ameriwood Home product, and to give us your valuable feedback.



Cubierta Delantera

Este libro de instrucciones contiene información **IMPORTANTE** de seguridad. Por favor lea y manténgalo para referencia en el futuro.

No Regrese este producto! Comuníquese con nuestro amistoso equipo de servicio al cliente para obtener ayuda. Llámenos al: 1-800-489-3351 (Gratis) Lunes - Viernes 9am - 5pm CST

Visitar: www.ameriwoodhome.com

PRECAUCION

Este mueble puede volcarse y causar graves heridas y/o muerte.

Anclar el mueble a un poste de madera en la pared (si esto se requiere).

No Permita que los niños monten el mueble.

Mantenga los artículos más pesados en los cajones de abajo.

Consejos Útiles (página 2)

- Abra su artículo en el área donde usted planea utilizarlo para evitar levantar y moverlo menos
- Identificar, ordenar y contar las piezas antes de intentar ensamblar
- Las clavijas de compresión se golpean con un martillo
- Las diapositivas están marcadas con una R (derecha) y L (izquierda) para la colocación correcta
- Asegúrese de que siempre este el punto localizado en la parte superior de bloqueador de leva este volteado hacia borde exterior
- Utilizar todos los clavos para el panel de atrás y distribuirlos por igual
- El panel de atrás debe utilizarse para asegurarse de que la unidad quede fija y firme
- No use químicas fuertes ni limpiadores abrasivos en este artículo
- Nunca empuje, tire ni arrastre los muebles

Antes de Que Empieces (página 3)

- Lea cuidadosamente cada paso y siga el orden correcto
- Separe y contar todas sus piezas y hardware
- Dése suficiente espacio para el proceso de ensamble
- Tenga las siguientes herramientas: destornillador de cabeza plana, #2 cabeza Phillips Destornillador y martillo
- Precaución: Si usa un taladro electrónico o un destornillador eléctrico para atornillar, por favor asegúrese que deje de atornillar cuando el tornillo este apretado. Fallar hacer esto puede causar barrer el tornillo.

Sistema de fijar el bloqueo de leva (página 3)

Este sistema de fijar el bloqueo de leva sera usado en todo el proceso ensamble.

Identificación de los Paneles (Página 4,5,6)

Este no es el tamaño real

- (A) Estante superior
- (B) Panel central
- (C) Panel central
- (D) Marco lateral
- (E) Left Middle panel
- (F) Panel de medio derecho
- (G) Panel trasero
- (H) Side panel posterior
- (I) Top panel lateral
- (J) Estante superior delantal
- (K) Lado izquierdo Rail
- (L) Lado derecho Rail
- (M) SIDE shelf
- (N) Puerta izquierda
- (O) Puerta de la derecha
- (P) Estante ajustable
- (Q) Rial
- (S) Tubo de apoyo
- (T) Chimenea

Lista de Piezas (Página 8,9)

Tamaño real

- (1) Clavija de madera
- (2) Tornillo
- (3) Tornillo
- (4) Tornillo
- (5) Perno de tornillo
- (6) Bolt
- (7) Bolt
- (8) Bolt
- (9) Tornillo
- (10) Caster

Este no es el tamaño real

- (11) Caster con cerradura
- (12) Cam Bolt
- (13) Cerradura de la leva
- (14) Escuadra
- (15) Washer
- (16) Soporte de repisa
- (17) Llave hexagonal
- (18) Spring washer
- (19) Washer
- (20) Magic Catch
- (21) Pegamento
- (22) Bisagra
- (23) Caster con cerradura
- (24) Manejar
- (25) Etiqueta de advertencia

Página 29,30

CARGA MAXIMA

Esta unidad ha sido diseñada para soportar la carga máxima anotada. El exceder estos límites puede causar inestabilidad, colapsarse y/o causar serias lesiones.

ADVERTENCIA: Riesgo de lesiones a las personas - no coloque un televisor sobre muebles. Este mueble no está aprobado para su uso con un televisor.

Página 31

Registre su producto para recibir lo siguiente:

- * Detalles de nuevas tendencias - Vistazo a lo nuevo
- * Encuestas - alec su voz entre su comunidad
- * Códigos de ofertas y descuentos exclusivos
- * Fácil y rápido servicio de partes de remplace

Para registrar su producto, visite ameriwoodhome.com

Clasificación de 5 estrellas

Visite el sitio web de su tienda local, califique su comprado y denos sus comentarios!

Nos gustaría enviar un gran "Agradecimiento" a todos nuestros clientes por tomarse el tiempo de ensamblar este producto de Ameriwood Home, y por darnos sus valiosos comentarios.

Gracias

Couverture Avant

CE LIVRET D'INSTRUCTION CONTIENT DES INFORMATIONS IMPORTANTES SUR LA SÉCURITÉ. VEUILLEZ LIRE ET GARDER POUR UNE RÉFÉRENCE FUTURE

Ne retournez pas ce produit! Contactez notre équipe de service à la clientèle amicale d'abord pour obtenir de l'aide.

Appelez-nous: 1-800-489-3351 (sans frais) du Lundi au Vendredi de 9h à 17h Heure Centrale

Visitez: www.ameriwoodhome.com

ATTENTION

Le meuble peut basculer et causer des blessures graves ou la mort.

Ancrer le meuble à une planche murale dans le mur (si indiqué).

Ne laissez pas les enfants grimper sur le meuble.

Placez les articles lourds sur les étagères ou dans les tiroirs inférieurs.

Astuces Utiles (page 2)

-Ouvrez votre article dans la zone que vous prévoyez de le garder pour moins de levage lourd

-Identifier, trier et compter les pièces avant d'essayer d'assembler

-Les goujons de compression sont taraudés avec un Marteau

-Les glissières sont marquées d'un R (droit) et d'un L (gauche) pour un bon placement

-Assurez-vous toujours de faire face la pointe situé sur le haut de la Serrure de Came vers le bord extérieur

-Utiliser tous les clous fournis pour le panneau arrière et les répartir également

-Le panneau arrière doit être utilisé pour vous assurer que votre appareil est robuste

-N'utilisez pas de produits chimiques agressifs ou de nettoyeurs abrasifs sur cet appareil

-Ne jamais pousser, tirer, ou faire glisser votre meuble

Avant de Commencer (page 3)

-Lisez attentivement chaque étape et suivez le bon ordre

-Séparez et comptez toutes vos pièces et matériaux

-Donnez-vous suffisamment de place pour l'assemblage

-Avoir les outils suivants: tournevis à tête plate, #2 tournevis Phillips, et Marteau

-Attention: Si vous utilisez une perceuse électrique ou un tournevis électrique pour visser, veillez à ralentir et arrêter lorsque la vis est bien serrée. Le non-respect de cette consigne peut endommager la vis.

Système de Fixation de Came (page 3)

Ce Système de Fixation de Came sera utilisé tout au long de l'assemblage

Identification des matériaux (Page 4,5,6)

Pas de taille réelle

- (A) top shelf
- (B) groupe d'intermédiaires
- (C) groupe d'intermédiaires
- (D) côté section
- (E) milieu gauche
- (F) juste milieu
- (G) arrière
- (H) côté arrière
- (I) haut de la page le côté
- (J) top shelf tablier
- (K) côté rail
- (L) côté rail
- (M) côté tablette
- (N) porte de gauche
- (O) porte
- (P) plateau réglable
- (Q) rial
- (S) les tuyaux
- (T) feu de cheminée

Liste des pièces (Page 8,9)

Taille réelle

- (1) goujon en bois e
- (2) visser
- (3) visser
- (4) visser
- (5) - bolt
- (6) bolt
- (7) bolt
- (8) bolt
- (9) visser
- (10) caster

Pas de taille réelle

- (11) caster avec serrure
- (12) cam bolt
- (13) cam -
- (14) Escuadra
- (15) lave - linge
- (16) soutien du plateau
- (17) la clé hexagonale
- (18) le printemps de lave - glace
- (19) lave - linge
- (20) la magie des captures
- (21) de la colle
- (22) charnière
- (23) caster avec serrure
- (24) manche
- (25) l'étiquette d'avertissement

Page **29,30**

CHARGES MAXIMALES

Ce meuble a été conçu pour supporter les charges maximales indiquées. En excédant ces limites de charge, le meuble pourrait devenir instable, s'effondrer, et/ou causer des blessures graves.

AVERTISSEMENT : Risque de blessure corporelle - ne pas placer une télévision sur ce meuble. Ce meuble n'est pas approuvé pour une utilisation avec une télévision.

Page 31

Enregistrez votre produit pour recevoir les éléments suivantes:

- * Détails sur les nouvelles tendances - un aperçu sur les nouveautés
- * Sondages - avoir une voix au sein de notre communauté
- * Offres exclusives et codes promo
- * Service de pièces de rechange rapide et facile

Pour enregistrer votre produit, visitez ameriwoodhome.com

5 Étoiles

Visitez le site Web de votre détaillant local, évaluez votre produit acheté et laissez-nous quelques commentaires !

Nous tenons à offrir un grand "Merci" à tous nos clients pour avoir pris le temps d'assembler ce produit "Ameriwood Home", et de nous donner vos commentaires précieux.

Merci